

RADIO *and Television* TODAY

NOVEMBER

SIX BC STATIONS OPERATING.

FIRST "COMMERCIAL" BC PROGRAM.

SUPERHETS, NEUTRODYNES. • FIRST BC CHAIN.

FIRST SHORTWAVE REBROADCAST. • FACTORY-BUILT SETS.

SOCKET-POWER UNITS. • FACSIMILE SHOWN.

YEAR OF WAVE-JUMPING AND AIR CHAOS.

FEDERAL RADIO COMMISSION CLEARS AIR.

BROADCAST REALLOCATION. • AC-OPERATED RADIOS.

SCREEN-GRID TUBES. • DYNAMIC SPEAKERS.

MIDGETS AND TABLE MODELS INTRODUCED.

AUTOMATIC VOLUME CONTROLS. • AUTO RADIOS.

SHORT-WAVE RECEIVERS BECOME POPULAR.

TUNING CONVENIENCES. • TELEVISION ICONOSCOPE.

HIGH FIDELITY SETS. • FCC TAKES OVER RADIO.

METAL TUBES. • NOISE-REDUCING ANTENNAS.

BUSINESS RECOVERY. • RECORD RADIO YEAR.

AFC. • PUSH-BUTTON TUNING. • COMBINATIONS.

TELEVISION. • WIRELESS CONTROLS & PLAYERS.

RECORDERS. FM. PORTABLES.

"CAMERA" PORTABLES.

MILESTONES
MARKING

20
YEARS
OF RADIO
PROGRESS

1921

1922

1923

1924

1925

1926

1927

1928

1929

1930

1931

1932

1933

1934

1935

1936

1937

1938

1939

1940

BEST BUYS! IN

Motorola



Motorola
SUPREME PERFORMANCE
is in the HEART OF THE SET

It's the Heart of the Radio... the works... that delivers supreme radio performance. And Motorola has plenty of "Heart," TONE... SENSITIVITY... and SELECTIVITY that only 3-gang Tuning can deliver. Make these 3 Tests Yourself... Discover Motorola's Heart!

- 1 Listen to Motorola's Concert Quality Tone. You'll find it pure, rich, sweet and full.
- 2 Check Motorola Sensitivity. You'll get many more stations—much greater distance.
- 3 Prove Motorola Razor-Sharp Selectivity. Get the stations you want sharply and clearly—one at a time.

Nationally Advertised
 FULL-COLOR PAGES IN
 SATURDAY EVENING POST AND LIFE
 NOW RUNNING

WRITE OR WIRE YOUR DISTRIBUTOR

1941 AUTOMATIC
 PHONOGRAPH-RADIO
 and HOME RECORDER

MODEL 93FI MIRACLE INSTRUMENT 10 BIG FEATURES!

- Makes Records of your Voice or Musical Talent.
- Makes Records of favorite Radio Programs.
- Makes Records of your Voice blended with the accompanying Music from your Radio.
- Re-records—makes Duplicate Records from your own Records or professional Records.
- Plays professional Records and any Records you may own.
- Can be used as a Public Address System.
- Automatically Changes twelve 10" or ten 12" Records.
- 3 Bands—American, Police, Amateur, Aircraft and Foreign Stations.
- 9 Tubes, including Rectifier—Push-Pull—3-Gang Tuning.
- Hot Electric "Feather-Touch" 6 Push Button Tuning.

MODEL RWI—PORTABLE RECORDER with EXCLUSIVE RECORD DUPLICATOR and WIRELESS PLAYBACK

Makes Home Recordings and also duplicates records. Playback home talent and professional records the "Wireless Way" through any Standard Broadcast Radio.

- Crystal Pick-Up and Cutting Head... Cuts and Plays up to 12" Records.
- High Quality Crystal Microphone.
- Powerful Constant Speed Rim Drive Turn-Table.
- Uses 5 Radio Tubes—Size 1 1/2" wide, 6" high, 10" deep.
- Duplicating Pedestal included—For Duplicating Any Professional or Home Records.
- Fabric Covered Portable Carrying Case Extra.



RADIO *and Television* TODAY

NOVEMBER

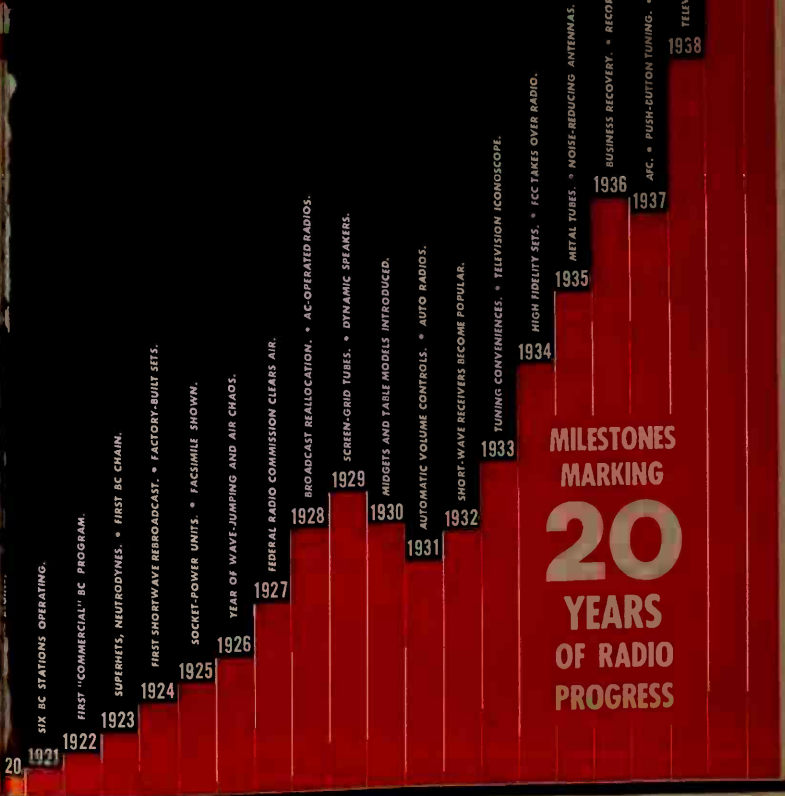

MILESTONES
 MARKING
20
 YEARS
 OF RADIO
 PROGRESS

GALVIN MFG. CORPORATION · CHICAGO

**Give Yourself
a Break -**

Only

***FP** (Fabricated Plate)
TRADE MARK REG. U. S. PAT. OFF.

**CONDENSERS
made by**

P. R. MALLORY & CO., Inc.
MALLORY

**Offer 2000 to 1 Odds
Against Comebacks**

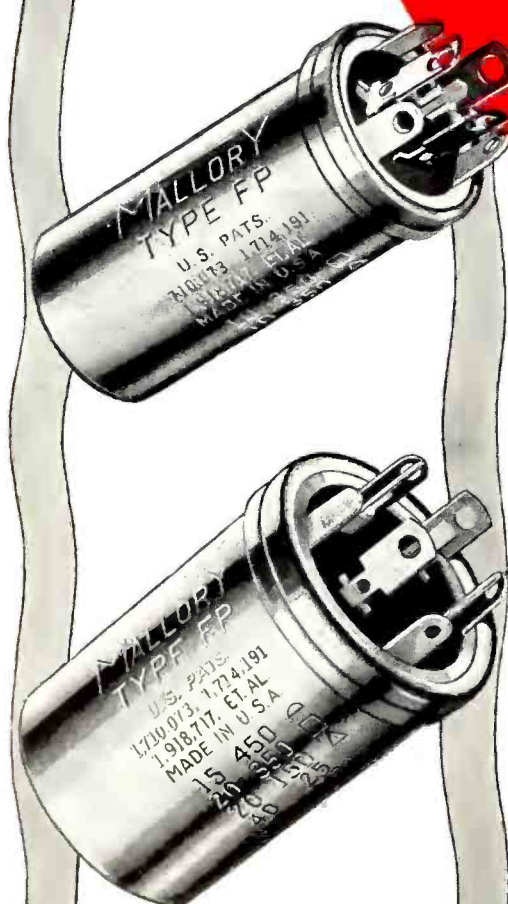

**Not etched construction*

FP Condensers, made by Mallory, give you the greatest insurance against comebacks ever offered. Here's proof!

In accurately checking the field returns from 1,000,000 FP Condensers purchased by representative radio manufacturers, it was found that only 512 were returned as defective. That's only 5/100th of 1%! It means dollars and cents to you for every Mallory-made FP Replacement Condenser is of exactly the same high quality.

Get all the facts on FP Condensers today. Find out how to identify the genuine. Get all the facts, too, on the complete coverage of the full line of Mallory Replacement Condensers. Your Mallory Distributor has the information . . . and the stock with which to serve you.

P. R. MALLORY & CO., Inc.
INDIANAPOLIS INDIANA
Cable Address—PELMALLO

Use

P. R. MALLORY & CO., Inc.

MALLORY
APPROVED
PRECISION PRODUCTS

Include

VIBRATORS • VIBRAPACKS • CONDENSERS • VOLUME
CONTROLS • ROTARY SWITCHES • SINGLE AND
MULTIPLE PUSH BUTTON SWITCHES • RESISTORS
RADIO HARDWARE

THE YANKEE NETWORK

Congratulates the

RADIO INDUSTRY

on its

TWENTIETH ANNIVERSARY

WNAC	Boston
WTIC	Hartford
WEAN	Providence
WTAG	Worcester
WICC	{ Bridgeport New Haven
WNLC	New London
WCSH	Portland
WLBZ	Bangor
WFEA	Manchester
WSAR	Fall River
WNBH	New Bedford
WHA1	Greenfield
WBRK	Pittsfield
WLLH	{ Lowell Lawrence
WLNH	Laconia
WRDO	Augusta
WCOU	{ Lewiston Auburn
WSYB	Rutland
WELI	New Haven

The Yankee Network now comprises 19 stations, providing complete and intensive coverage in the key shopping centers of New England.

Thirteen cities in 10 counties account for 68.5% of New England's retail sales—and in 13 counties, 75.6% of the retail sales are produced. In every strategic buying area The Yankee Network dominates—in many markets its coverage is exclusive!

The particular type of local acceptance this provides, insures

response that is possible only thru this combination of stations.

Now—with normal, prosperous industrial operations augmented by huge defense orders (New England Council reports \$1,161,331,539 for June 13 to Oct. 5 alone) New England is one of the biggest ready-money markets in America.

Plan to take immediate action to get the benefit of this increased buying power with a consistent campaign on The Yankee Network.

THE YANKEE NETWORK

21 BROOKLINE AVENUE

BOSTON, MASS.

EDWARD PETRY & CO., INC., *Exclusive National Sales Representative*

UTAH K15P L15P

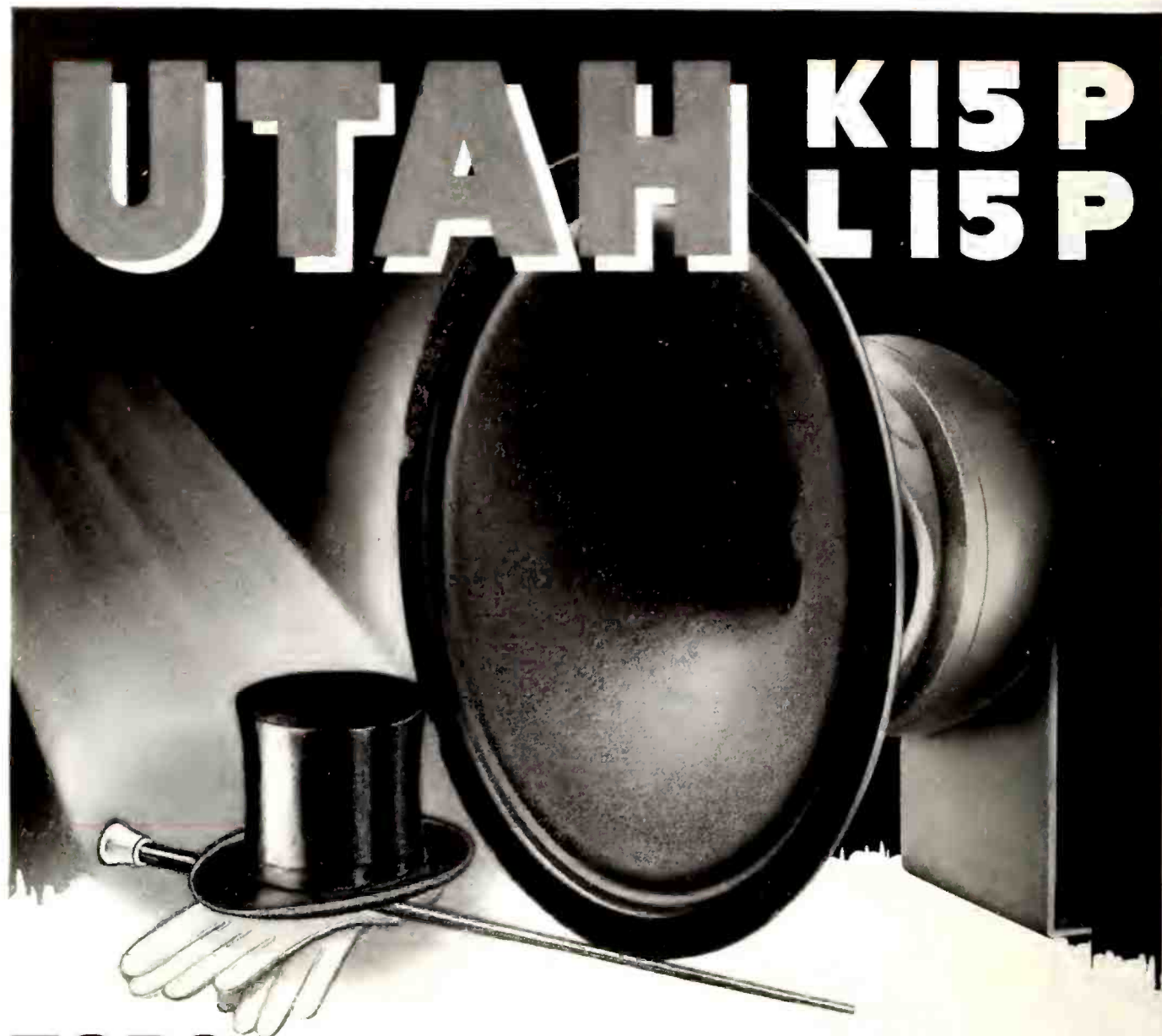

TOPS for auditoriums or theatres

For absolute "tops" in sound reproduction with cone type speakers, use the Utah K15P or L15P. They are unsurpassed for speech and music in public address applications.

These outstanding representatives of the well-known Utah speaker line have *extremely high power handling capacity*. They have an efficiency of 4 DB above any other Utah speaker ever produced. Owing to their high efficiency, they're ideal for "woofers" applications in two-channel systems.

Check these features: Specially treated for atmospheric conditions—2-inch 8-ohm voice coil over

½ inch deep—spider of exclusive Utah design and material permits release of back pressure found in ordinary construction—greatly improved bass response—exceptional brilliance in the voice range—magnet weight 15 lb. and 23 lb. List price \$79.50 and \$104.50 (subject to standard trade discounts).

Write for full details about the complete line of Utah speakers. UTAH RADIO PRODUCTS COMPANY, 814 Orleans Street, Chicago, Illinois. Canadian Office: 560 King Street, West, Toronto. In the Argentine: Ucoa Radio Products Company, S. R. L. Buenos Aires. Cable Address: Utaradio, Chicago.



S P E A K E R S

VIBRATORS • TRANSFORMERS • UTAH-CARTER PARTS

See the sensational new CAPEHART - FARNSWORTH record changer! One of the biggest sales producers ever introduced. Plays 14 tens or 10 twelves. Quiet. Prospects see it, try it, buy it!



★ **THERE'S FAR MORE TO THE FARNSWORTH LINE THAN THE CAPEHART-FARNSWORTH RECORD CHANGER!**

TRUE — the Capehart-Farnsworth changer is the hottest selling feature in combinations today. But Farnsworth gives you a lot more.

A tremendous range of up-to-the-minute styles! FARNSWORTH spells VALUE. Competitive from every angle!

Sell Farnsworth

★ **FARNSWORTH GIVES YOU EVERYTHING**

FARNSWORTH offers the broadest line in the industry! Chairside combinations — superb cabinet phonograph-radios and radios! Gifts that put other presents in the shade! You can sell these *hot* models F-A-S-T — at Christmas and throughout the year. Radios for bedrooms, for children going back to school, for family group gifts.

Give yourself a Christmas present with FARNSWORTH'S wide margin of *profit*! Get the facts—*today*. FARNSWORTH TELEVISION & RADIO CORP., FORT WAYNE, INDIANA.

★ **TYPICAL FARNSWORTH VALUE LEADERS!**



BK-112 (Jefferson). This splendid example of fine period designing is tops in the Farnsworth line! In mahogany or walnut. A knockout for the carriage trade!



BK-89 (Regency). Here is a great big package for the money! Features front opening doors — a clinching sales point to a tremendous number of prospective customers!



BK-87 (Stratford). This impressive, fast-moving combination has great appeal for those who want period furniture. Available in either mahogany or walnut.

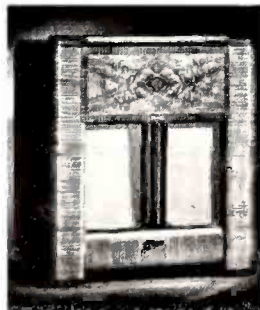

BK-85 (Modern). This combination sells itself on sight! Conservatively modern, classically simple. Also available in blond. A sales-producing bargain!



BK-73 (Classic). The hottest chairside model the industry has produced! Walnut or blond. *Automatic record changer.* Looks to customers like a swell buy — and is!



8C-82. This lowboy console is a marvelous performer in a distinctive cabinet.



8T-70. Beautifully styled, this table model looks like a small console. Real quality for little money.



8T-61. A superb instrument for both tone and cabinet-work. Compact and modern. At a "take-away" price!



8T-55. This handsome, ultra-modern table model is really smart styling! A honey for the money. Excellent tone.



8T-71. A distinguished model, unusual in its period trim, and richly grained woods. At a price that says "Buy me."

FARNSWORTH . . . MAKERS OF RADIO AND TELEVISION TRANSMITTERS AND RECEIVERS, THE CAPEHART, THE CAPEHART-PANAMUSE AND FARNSWORTH PHONOGRAPH-RADIO COMBINATIONS

Special low deposits on all N. U. Triplett Deals to November 30th

TRIPLETT
TUBE TESTER
Model 1620
\$12.50
DEPOSIT

TRIPLETT TUBE TESTER
MODEL 1620

Has new lever-type flexible switching giving individual control for each tube prong . . . Filament voltage switching from 1.1 to 110 takes care of present and future tubes with filament voltages up to 117-volt types . . . Giant 6-inch scale RED•DOT lifetime guaranteed indicating instrument . . . Neon short test . . . Separate line voltage meter . . . Speed Roll Chart can be spun from one end to the other in less than four seconds . . . Housed in wooden case of graceful proportions with sockets, knobs and markings in ivory.



TRIPLETT
MODEL 1620
Regular Dealer
Price \$37.84

and it's Yours
on N.U. DEAL

Over 50,000
completed deals
your guarantee
of complete
Satisfaction



J. E. STAGE, Longvicu Radio Sales & Service Co., Longvicu, Wash. Think your Free Equipment Plan great—Have signed 20 N U Equipment Deals—have been using N U program 9 years. N U tubes all check alike—rarely have to make replacements.



MATHEW J. BERLOWITZ Juncau Radio Shop, Milwaukee, Wisconsin. I find in checking my records I signed 29 contracts. There is no better way for a serviceman to painlessly acquire good service equipment. In my 10 years of exclusive dealing with N U their products have always been satisfactory.



E. J. MAGINOT, Boston, Mass. In my opinion, and in the opinion of many other service engineers with whom I am associated, N U enjoys a prestige which needs no apology. Modern radio sets demand modern testing equipment. N U supplies it the easy way.

YOU TOO CAN HAVE THE
"Best Equipped Shop in Town"

Get it the National Union way . . . you deposit \$12.50, immediate delivery is made on Triplett Model 1620 Tube Tester. You sign agreement to purchase 875 points over a 2 year period. On completion you receive bill of sale and your deposit is refunded as a merchandise credit.

☆☆☆

National Union purchase points can be taken in Tubes, Condensers or Batteries. All products the finest in quality, thoroughly guaranteed and competitively priced.

☆☆☆

Ask Your Jobber or Write to

National Union Radio Tubes are known as the radio service dealer's tubes because they are used by more service dealers than any other make.

☆☆☆

You too can have the best equipped shop in town, just get your equipment the easy "N. U. Way" — Remember National Union has the finest sales helps and promotional pieces to help you sell yourself to your community and make more money.

☆☆☆

Special low deposit on all Triplett Testers until Nov. 30th, 1940.

NATIONAL UNION RADIO
57 STATE STREET, NEWARK, N. J. Corp.

The Best Equipped
Shop in Town
Gets the Business

Copyright

Centralab's New Trimmer CERAMIC CONDENSER

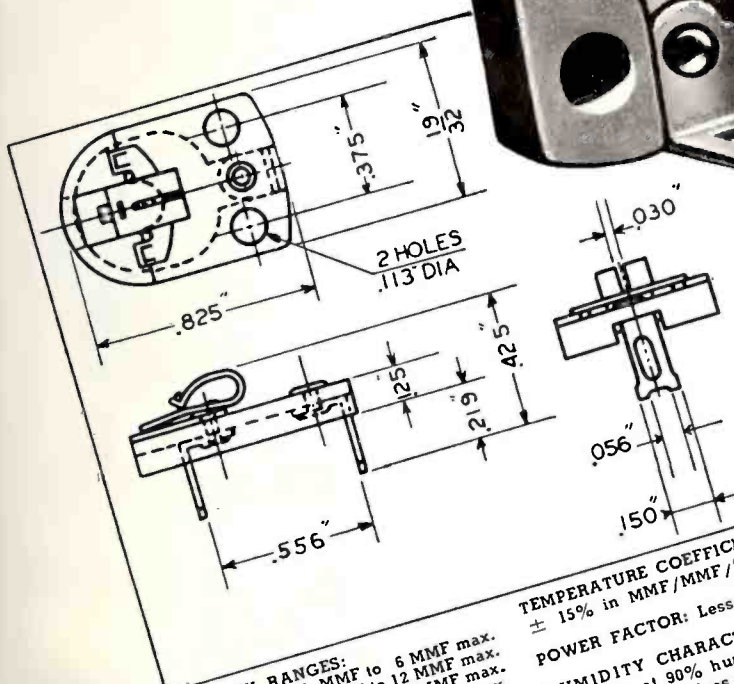

CAPACITY RANGES:
 (a) Less than 2 MMF to 6 MMF max.
 (b) Less than 3 MMF to 12 MMF max.
 (c) Less than 7 MMF to 30 MMF max.
 (d) Less than 60 MMF to 75 MMF max.
 Other ranges may be manufactured if in demand.
RETRACKING: After repeated cycles of heating and cooling, capacity change is less than 0.5%.

TEMPERATURE COEFFICIENT: $-.0006 \pm 15\%$ in MMF/MMF/ $^{\circ}\text{C}$.
POWER FACTOR: Less than 0.1%.

HUMIDITY CHARACTERISTIC: After 100 hours at 90% humidity, 40°C , capacity change is less than 0.5%, power factor reading less than 0.15%.

There are no erratic capacity changes with the new Centralab Trimmer Condensers . . . the dielectric and base are all one piece moulded under pressure with a ceramic so dense that no temperature or humidity changes can affect it. The stationary plate is silver, bonded to the ceramic with no air film between. The movable plate is metal, rotatable on the flat ground surface of the ceramic . . . a worthy companion . . . and a new member of the famous CENTRALAB family.

CENTRALAB Div. of Globe-Union Inc., Milwaukee, Wis.

DOWN THRU THE YEARS -

from **CATWHISKER**

to **ELECTRONIC MUSIC!**

Highlights of Radio Pioneering by Benjamin Franklin Miessner

1909-1910 CATWHISKER. Outgrowth of experiments to make crystal detectors immune to mechanical shock as by gunfire aboard ship. Patent issued July 21, 1914. No. 1,104,065. Sold to Wireless Specialty Apparatus Co.
Conceived and recorded INDUCTOR COMPASS.

1911-1912 SUPERHETERODYNE. Evolved in development work to eliminate interference in torpedo control by radio. Very close to the type of superheterodyne later introduced by Armstrong, Alexanderson and Hammond. Main difference was IF source at transmitter instead of in receiver. Also pioneered cascade T.R.F. amplifier and many other developments.

1916-1918 Pioneered AIRCRAFT RADIO development for U. S. Navy. Also anti-noise directional microphones and noise measuring instruments.

1919 FREQUENCY MODULATION and Amplitude limitation systems. Conceived and recorded.

1919-1930 ALL-ELECTRIC SET with AC TUBES, progressive filtration, hum bucking filters, hum bucking coils in dynamic speakers. Covered by 60 patents. Used by 25 licensees. Sold to RCA, 1930.

1920 SINGLE CONTROL. First uni-controlled receiver built as a marine direction finder. Had 3-gang condenser, tuning two RF stages and detector. Individual trimmers. Fore-runner of present-day ganged tuning.

1920-1922 FIRST ELECTRICALLY RECORDED records and reproducers, made for Brunswick, Chicago. Pioneered multiple microphone pick-up, variable reverberation studios, etc.

1930-1940 ELECTRONIC MUSICAL INSTRUMENTS. 50 patents covering various phases of electronic pickup, reproduction, tone control, etc., as applied to organs, pianos and other instruments. Manufacturing licenses granted to leading instrument makers.

These are but a few of Miessner's many pioneer developments.

TODAY, when all radio is celebrating "Twenty Years of Progress," it is gratifying to me, as it must be to other oldtimers, to look back upon our early efforts and realize how greatly those efforts have contributed to radio as we know it today—how far-reaching they have been in bringing countless blessings to a troubled world.

Broadcasting, with its decisive effect on world affairs; with its immeasurable capacity to furnish information and entertainment; with its great uplift in musical appreciation, has had a transformation that would have seemed fantastic 20 years ago. But, no more fantastic than "wireless" on which a few of us were concentrating ten or fifteen years before broadcasting began.

No one could foretell, and few can remember, that it was my good fortune to invent the now-historic catwhisker detector, thereupon beginning a 30-year span of development which has left an indelible mark on radio.

Now, and for some years past, my main interest has been ELECTRONIC MUSICAL INSTRUMENTS, for which I have found ways of using the vacuum tube to give music itself a totally new realm of tone quality and tone control.

Undoubtedly there have been times when you have felt yourself under the spell of a magnificent organ. Perhaps you have also marveled at the tonal qualities of a fine piano. Or a fretted instrument. More than likely, you were listening to an ELECTRONIC MUSICAL INSTRUMENT!

In my opinion, this type of instrument is supreme. The ultimate. And my enthusiasm is evidenced by 50 patents under which leading instrument manufacturers are licensed. Yes, the Day of Electronic Music is here. It brings an opportunity for manufacturers to engage in a lucrative field without investment or risk; without change of plant facilities; with development work completed and none of the trade evils of radio.

Miessner Inventions, Inc.
Millburn, New Jersey

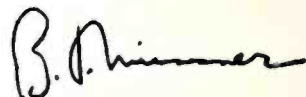

MIESSNER

G-E RADIOS

Packed with Quality

for Christmas Selling



No question about it! G-E Golden Tone Radios *have what it takes* to round up sales.

Plenty of eye and ear appeal! Glorious tone—brilliant styling—new and exclusive plus-value features!

And—best of all!—they're priced right down where sales are thickest!

Feature G-E Golden Tone Radios prominently—on your sales floor, in your windows—*right through the holiday season*. They'll help you make this a Merry Christmas.

20th ANNIVERSARY RADIO INDUSTRY

1921 - 1941



MODEL J-805

A beautiful Console in Two-tone American Walnut and Stripe Sapeli Wood Veneers. Equipped with *Dual Beam-a-Scopes* for finer foreign and domestic reception.



MODEL JB-410

The Hit Of The Christmas Season! New Camera-type Carryabout designed to resemble a small camera. Longer Battery Life. Case is simulated leather with dark maroon plastic trim.



MODEL J-501

A low priced super-heterodyne in smartly styled Plastic Cabinet. Two colors—Ivory and Mottled Mahogany.



MODEL J-629

The Complete Musical Instrument! Radio Receiver, Record Player and Home Recorder—all in one! New this season!

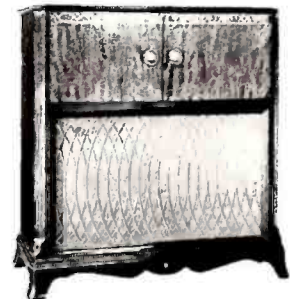

MODEL J-718

A fast-moving automatic Radio-Phonograph Combination. Exquisite Cabinet in Figured Mahogany Veneers.

Radio and Television Department, Bridgeport, Conn.



GENERAL ELECTRIC



★

Talk about being in radio!

Radio's radio and there's nothing else like it. It's that something you see in a kid's eyes. It's a home run with the bases full. It's the anvil and the forge. It's a symphony that's always listening for one more note. That's radio.

When people are "in radio" as we are, from the winding of tiny wires to the designing of giant transmitters, from the conception of a program idea to its reception in millions of homes, they have something extra to offer you. Call it pride, or craftsmanship or rounded experience—it adds up to better radio. And that can mean greater returns for your money when you advertise on our stations.

WESTINGHOUSE RADIO STATIONS

WBZ-WBZA
Boston

KDKA
Pittsburgh

KYW
Philadelphia

★
WOWO-WGL
Fort Wayne

Represented Nationally by NBC
Spot Sales Offices

Photo at left shows the giant 718 foot KDKA antenna

RADIO *and Television* TODAY

RADIO'S JOBS HAVE JUST BEGUN!

As radio men pause to look back on 20 years of unparalleled accomplishment in changing the habits of the nation and enriching the daily life of our people, let us also glance ahead at the jobs yet unfinished:

1. Clear, undisturbed reception must be afforded every home and every community.
2. Not only must each home have a modern quality radio, but there should be an individual set for each member of the household,—and for the principal rooms of the home.
3. Through auto-radios, office radios and pocket-portables, active persons everywhere should be able to keep in touch with radio every hour of the waking day.
4. Radio men and the public need to distinguish two groups of receivers—(a) "Music radios" of high fidelity for listening to musical and dramatic productions and (b) "Voice radios"—receivers of greatest compactness and convenience for news and "keeping in touch."
5. Electronic musical instruments have opportunities in every home and musical group.
6. Sound amplification so far has touched barely a tenth of its possible market.
7. Better servicing methods, wider use of quality tests equipment, and more competent trained men are needed to keep our millions of devices in operating condition.
8. Television, facsimile, photocell uses and electronic devices promise to pyramid our present market, as these new services become available and understood by the public.

And so the radio man's horizon stretches out ahead for 1941 and beyond. Endless business opportunities are in sight, as each rich new vein of radio development is tapped.

EDITOR, Orestes H. Caldwell;
PUBLISHER, M. Clements;
Managing Editor, Darrell Bar-
tee; Merchandising Editor, H.
L. M. Capron; STAFF, E. T.
Bennett, N. McAllister, G. H.
Mayorga, William E. Moulic,
M. H. Newton, R. A. Neubauer,
B. V. Spinetta, R. Y. Fitz-
patrick, 201 N. Wells St.,
Chicago, Ill.; CALDWELL-
CLEMENTS, INC., 480 Lex-
ington Ave., NEW YORK,
N. Y. Telephone PLaza 3-1340.
Copyright 1940. Member Aud-
it Bureau Circulations. Vol.
6, No. 11. November, 1940.

CELEBRATING



Dr. Frank Conrad of Westinghouse began experiments in 1912, leading to KDKA debut.



B. F. Miessner, whose inventive trail leads from catwhisker, through single-dial control and AC sets, to electronic music.



Dr. Ray Manson, with Stromberg-Carlson since 1916, and now g.m., holds many radio patents.

Big Events for Radio's Birthday, Nov. 11-30

All branches of the radio industry are entering into the current celebration of Radio's Twentieth Birthday Anniversary, being conducted Nov. 11 to 30, under the joint auspices of the National Association of Broadcasters, the Radio Manufacturers Association and the Radio Servicemen of America.

Elaborate programs marking the twentieth birthday of Radio will be presented during the period by the national networks and by independent stations. NBC, CBS and MBS have all shaped up special features, and under the leadership of NAB, advance plans have been made by broadcasters all over the country to conduct commemorative programs and hold open house for visitors.

BIRTHDAY DINNER AT WASH., D. C.

A big Twentieth Birthday Dinner is to be held at Washington, D. C., during the latter half of the month, with Cabinet members, members of Congress, Army and Navy officers and government dignitaries attending. Similar birthday dinners are planned in other cities.

Word has also been received that a number of special Radio Birthday sections in newspapers will be published during the twenty days, November 11-30. Editorial copy for these sections will mostly concern local radio men, local dealers and distributors, and local stations and their programs.

80-MILLIONTH RADIO

America's 80 millionth radio set, scheduled to come off the production lines during this period, will be presented to President Roosevelt, probably in connection with the dinner ceremonies.

A tribute to the broadcasting industry from the United States Civil Service Commission is to be a part of Radio's 20th Birthday celebration. Such appreciation is an official act of the Commission and will be sent to stations in the form of a recording for broadcasting during the 20-Day party.

In line with the RMA, the National Radio Parts Distributors Assn. has mailed broadsides to members in all parts of the country.

Emerson Radio, Farnsworth Radio, Motorola, RCA-Victor, Westinghouse and others are distributing Radio Birthday broadsides to distributors and dealers.

Radio dealers, servicemen and distributors are urged to tie in with the

nationwide plans for Radio's 20th Birthday by presenting special window displays and store decorations and by promoting special advertising and merchandising plans before their local publics.

PLANE TO TRACE RADIO HISTORY

The "Radio Magic" program conducted every Friday at 7:30 p.m. EST over NBC Blue Network stations by Editor Caldwell of *Radio Today*, will initiate the 20th Anniversary celebration at New York with a broadcast from an Eastern Airlines plane circling over the metropolitan area. This broadcast of Friday evening, Nov. 15, will describe the events of historic radio interest which occurred within sight of the plane's course, while it is linked by shortwave with the NBC Blue Network. Other "Radio Magic" broadcasts on following Friday evenings in November will pay tribute to radio sets and their service to the American public, in accordance with the schedule on this page.

"TWENTY YEARS OF RADIO PROGRESS"

"Radio Magic," WJZ and NBC Blue Network, Fridays, 7:30 p.m. EST, 6:30 p.m. CST

By O. H. CALDWELL,
Editor RADIO TODAY.

Nov. 15—I—"Milestones of Radio, 1920 to 1940." The Beginnings of Broadcasting. Locations in New York City and Vicinity Which Made Radio History, as Viewed from Airplane, from Which the Broadcast Will Be Conducted.

Nov. 22—II—"From Crystal Set to Superhet." The Story of Home Receivers. Building Always Toward Better Reception and Greater Convenience for the Listener. Improvements in Tubes and Speakers. Modern Fidelity and Lifelike Reproduction. How to Get the Most Out of Your Radio Receiver.

Nov. 29—III—"Radio's Effects on Home Life." What It Does for Us from Dawn 'til Bed-time. Time, Weather, News, Music, Drama, Education of the Masses. Creating New Alertness and Awareness Throughout the Nation. Family IQ's and Listening Hours.

During December, continuing on Friday evenings at 7:30 p.m., "Radio

20 YEARS

"Magic" programs will promote the merits of radio sets as ideal Christmas gifts for all members of the family.

The above programs will be simultaneously broadcast by shortwave, and also by frequency modulation at 44 megacycles, from the Empire State tower. On each Sunday following, at 12:30 p.m., these Radio Magic programs are repeated to South America and Europe over WNBI (17.78 megacycles).

More Television On the Air

Several television transmitters are now occasionally back on the air, in their new channels, and this month created wide interest with their coverage of the national elections. The NBC station in New York City, for instance, broadcast special campaign events and election reports for an estimated audience of 100,000, and demonstrated the value of the new medium for transmitting flash reports of teletype tapes from all over the U. S. Some 45 special receivers were set up in New York and New Jersey to test out audience reaction in radio dealers' stores.

Early in January, more action is expected in this field when the FCC confers with the National Television Systems Committee, to review the progress of the art.

FM Goes Commercial

The official okay has been given by the Federal Communications Commission to 15 FM stations, for commercial operation in a dozen different cities throughout the country. The FCC thus acted on about 1/3 of the license applications pending, and has indicated that more will be granted shortly.

Four of the 15 FM pioneers are located in Metropolitan New York; others are in Detroit, Los Angeles, Schenectady, N. Y., Evansville, Ind., Mt. Washington, N. H., Binghamton, N. Y., Baton Rouge, La., Columbus, Ohio, Salt Lake City, Chicago, and Milwaukee. It is estimated that some 27,000,000 persons in 110,000 sq. mi. of potential service area will be reached by these stations.

The first FM network of 42 stations is being mentioned for the fall of 1941, according to plans of the Yankee-Colonial radio web.

David Sarnoff, president of RCA, and wireless veteran since Marconi days, talks over radio history with Dr. E. F. W. Alexanderson of General Electric, whose famous alternator and electronic amplifier were high spots in an invention record that has averaged a radio patent every seven weeks for 35 years.

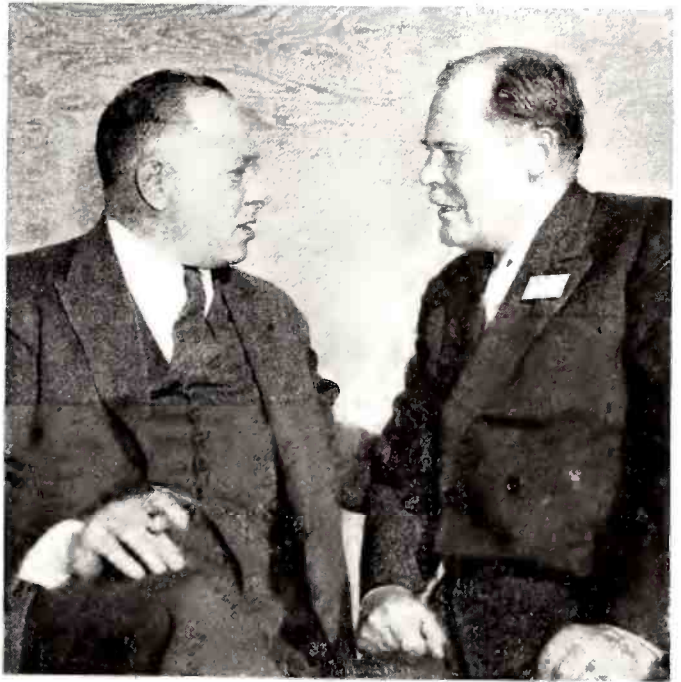

What They Cost Per Pound

Next time you meet the argument that radios cost too much, come back with a comparison of radios by weight, in contrast with other commodities.

Radios can be dished out for about \$1.50 a pound, at current prices. So get noisy about the fact that your "million-dollar entertainers" are thus selling for prices similar to those paid for fine candy, or for books. The latter items may be a delight, but they're awfully temporary, compared with a 5-year ticket to the world's choicest events.

Down the street, autos are selling for 20c. per lb.; beefsteak at 30c., electric refrigerators at 40c., and pianos at 90c.—all per pound. A type-

writer costs \$2.75 a pound, a decent suit of clothes, \$7.50, a dollar watch \$10, a fountain pen \$125, and eye glasses \$160!

Front-Cover "Milestones and Sales"

Our front cover shows principal radio events and advances during the past 20 years.

But the heights of the "milestones" also indicate the growth of the radio business year by year—the columns being proportional to the number of radio sets sold during these years.

Complete statistics on the present magnitude of the radio industry and trade, at Radio's 20th Birthday Anniversary, are presented on pages 19 and 21.

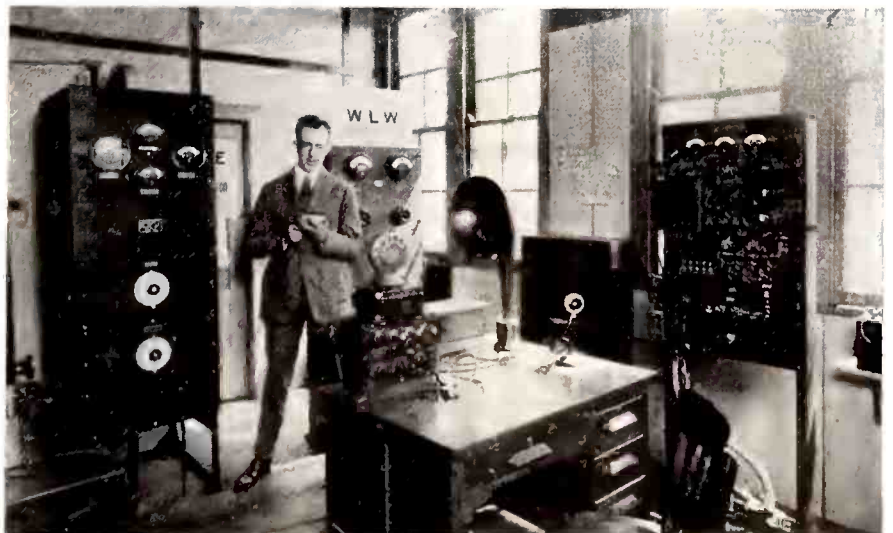

When WLW was young—the original control room at Cincinnati showing Powel Crosley, Jr., of Crosley Radio Corp. during a broadcast in 1922.

Specially for the gift market, the colored "Coronet" by Sonora, \$18.95



Admiral offers this automatic combination 64-K5 table job for \$49.95.

RADIO

From the holiday-looking Musaphonic series by GE, Model 60 Chippendale.



Above the new Stromberg in Salem Chest design, 520-PS, automatic.



At the right, a Christmas hint by Linda Jane Klaber and Emerson.

The much-discussed Philco PT-2, with the 4 1/2 in. oval speaker. Sleek superhet for \$14.95.

The onyx bakelite Sentinel 218-0 in Xmas setting. AC-DC job for \$16.95.

One of the new Radiola units from RCA, 5-tube model 510 in brown plastic.

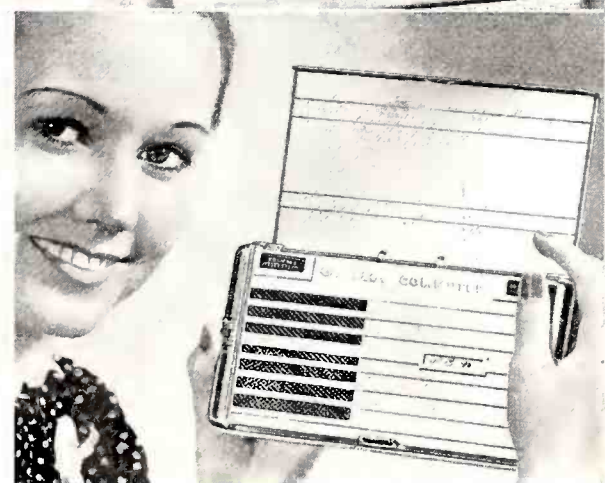
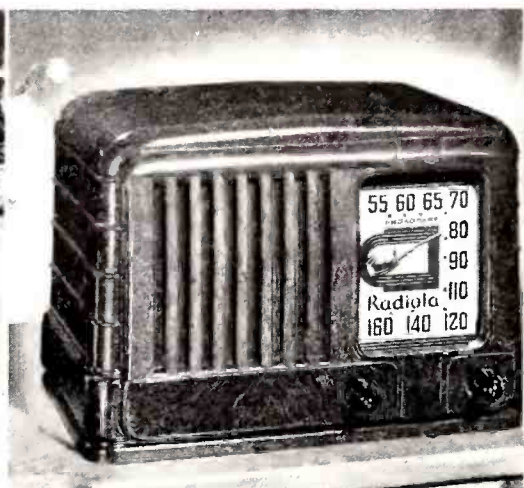

Semi-period cabinet makes the Farnsworth BT-71 distinctive. Two waveband set, 7 tubes.

Automatic Consolette by Port-O-Matic Corp., 50 E. 77th St., NYC.

Crosley's streamlined "Commuter" radio in aluminum case, model 45BV at \$19.95.

PROGRESS AT XMAS PEAK

This distinguished "Contemporary" model radio-phonograph by Magnavox is an automatic and many-featured unit, \$198.50.

Here's the Wilcox-Gay A-94 Recordio, 18th Century style, dual speed feature, automatic changer.





Specially for the gift market, the colored "Coronet" by Sonora, \$18.95.



The much-discussed Philco PT-2, with the 6-in. oval speaker. Sleek superhet for \$14.95.



The onyx bakelite Sentinel 218-0 in Xmas setting. AC-DC job for \$16.95.



One of the new Radiola units from RCA, 5-tube model 510 in brown plastic.

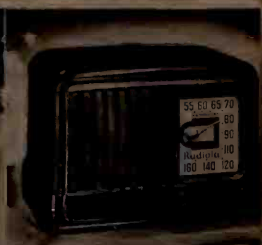

Admiral offers this automatic combination 64-K5 table job for \$49.95.



Semi-period cabinet makes the Farnsworth BT-71 distinctive. Two waveband set, 7 tubes.



Automatic Console by Port-O-Matic Corp., 50 E. 77th St., NYC.



Crosley's streamlined "Commuter" radio in aluminum case, model 45BV at \$19.95.

RADIO PROGRESS AT XMAS PEAK

From the holiday-looking Musaphon series by GE, Model 60 Chippendale.



Above the new Stromberg in Salem Chest design, \$20-PS, automatic.

This distinguished "Contemporary" model radio-phonograph by Magnavox is an automatic and many-featured unit, \$198.50.



At the right, a Christmas hint by Linda Jane Klaber and Emerson.

Here's the Wilcox-Gay A-94 Recordio, 18th Century style, dual speed feature, automatic changer.



TWENTY YEARS OF RADIO

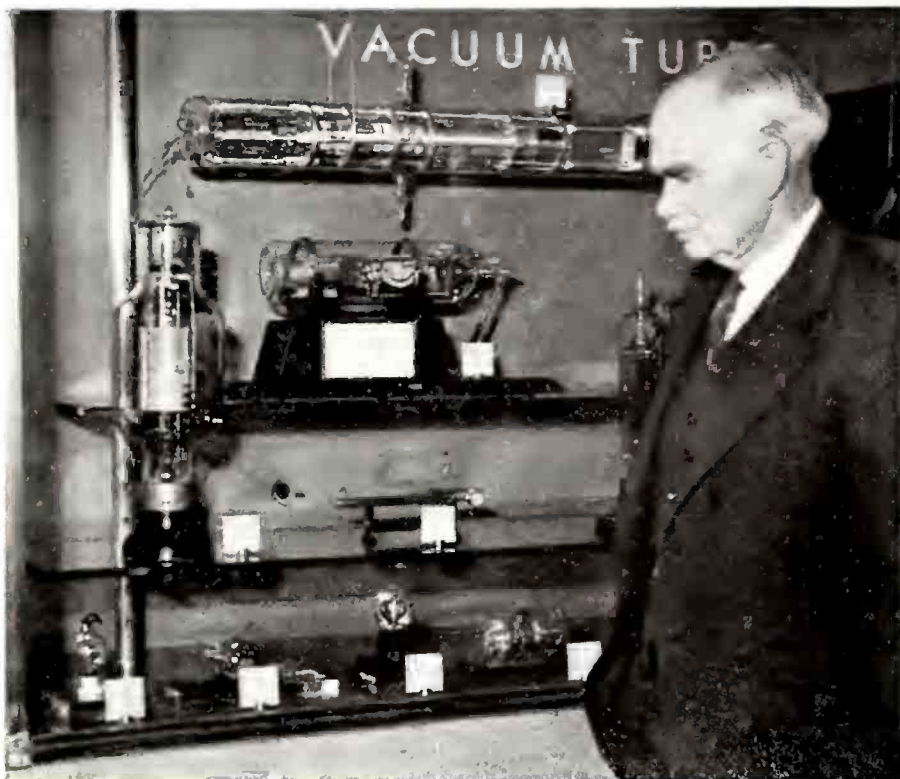

Dr. Lee deForest inspects his early audions (bottom shelf, left)

It was in 1920, just 20 years ago, that the first regular radio program went on the air, and an unfamiliar word—"broadcasting"—was first applied to the new art of sending music, speeches and drama through the air, to people sitting comfortably at home and "listening in."

But while 1920 marks the launching of radio broadcasting as we know it today, there were long years of discovery and invention ahead of that,—years of painstaking work that laid the foundations for the glorious 20-year period we now celebrate.

It was just a hundred years ago, at Princeton, N. J., that Joseph Henry, pioneer American scientist, sent the first wireless signal between two antennas 400 ft. apart on the Princeton College campus. He had no way to detect his signal in his receiving antenna except to have the current magnetize a steel needle.

EDISON'S "BLACK BOX"

Also in New Jersey, at Menlo Park, in the eighties, Thomas Alva Edison, while working on his incandescent electric light, discovered the Edison Effect, the faint phenomenon of electron emission which underlies all radio and electronic tubes. It was at Menlo Park, too, that Mr. Edison had as early as 1879 carried on his famous "black-box" experiments producing "etheric force" as he called it

—or radio-frequency currents as we know them today. This method of producing tiny sparks in a hooded black box on the opposite side of the room, was exhibited at the Paris Exposition in 1881, and closely resembled the famous Hertz oscillator which Hertz announced in 1887 and which is generally viewed as the starting point of all experiments on the propagation of radio signals through space.

But Edison was too busy with his myriad other inventions, to follow up these two pioneer sallies into the future radio field. Indeed it is doubtful if at the time he realized the future relationship of these two cornerstones of the new art. He merely jotted them down in his crowded notebook and so the next chapters of radio history came from abroad.

MARCONI'S SIGNALS

In Italy, in the nineties, young William Marconi experimented in his home garden with principles previously enunciated by Clerk Maxwell and by Heinrich Hertz, and succeeded in sending signals 1500 ft. Later Marconi went to England and with Sir Oliver Lodge, who suggested tun-

The original superheterodyne receiver is shown here with its inventor, Major Edwin H. Armstrong, who has recently made more radio history by developing FM.

ing, soon succeeded in sending messages 200 miles.

Coming to America in 1899, Marconi set up the first wireless station operated in this country, at the Highlands of Navesink, near Sandy Hook. There, by the use of a signal mast normally used for flag signals by the U. S. Coast Guard, Marconi communicated from the S.S. *Ponce* when he reported the international yacht races in 1899. The Marconi Wireless Telegraph Company of America, forerunner of the present RCA, was formed in that same year, and in 1901 the first permanent wireless station in the U. S. was erected by that company, at Babylon, L. I. This primitive structure is still extant, and stands beside its huge modern brothers at Rocky Point, Port Jefferson, N. Y.

It was at the close of the same year, 1901, that Marconi again made history, when at St. Johns, Newfoundland, he sent up a kite antenna, by means of which on December 12, 1901, he heard the letter S (three dots), transmitted 2500 miles across the Atlantic, from the Marconi sending station at Poldhu, England.

Looking northward over Manhattan, one can see, up along the Harlem



AMAZING STORY

Compiled for broadcast Nov. 15 over NBC network, from plane flying over New York City, in "Radio Magic" series by Editor Caldwell of Radio Today.

River, Highbridge, the site of the laboratory of Lee de Forest, who in 1906 took the Fleming valve detector, based upon the famous "Edison Effect," and by adding a grid, made it capable of performing all the wonders of the modern radio tube. A small electrical force put on this grid is able to control the flow of tremendously larger electrical forces flowing across the vacuum in the form of streams of electrons—very much as a child can turn a switch that will start or stop a huge electric locomotive.

So with the invention of the three-element tube, both a sensitive detector and a powerful amplifier were made available to pick up feeble incoming radio impulses.

In the middle distance, on Morningside Heights, we glimpse the buildings of Columbia University, where the young Edwin H. Armstrong, pupil of Prof. Michael Pupin, experimented with the regenerative receiver and other radio circuits.

ARMSTRONG'S INVENTIONS

It was at Columbia University that young Armstrong built his second superheterodyne receiver—the first of which had been put together with sweat and hard toil on the battlefields of France—and at Columbia also he designed and built his first super-regenerative receiver, and his first frequency-modulation apparatus. His first frequency-modulation station was at the Amakassin Club, in Yonkers, directly across from Armstrong's present huge station at Alpine, N. J.

And below us, as we fly, is the Metropolitan Opera House, from a rooftop room of which Dr. deForest on January 13, 1910, broadcast the voice of Caruso to the S.S. *Avon* at sea and to an audience of perhaps fifty listening experimenters scattered over the New York area. Thus, 30 years ago, occurred experimentally, this first of Metropolitan Opera broadcasts which now mean so much to the NBC audience of many millions.

KDKA'S FIRST BROADCAST

KDKA's first broadcast of election returns in the Harding contest of November, 1920, has been generally accepted as one of the milestones of radio, but there lay behind KDKA a number of years of broadcast experimentation by Dr. Frank Conrad, assistant chief engineer of the Westinghouse company. In his garage laboratory, Dr. Conrad had for years conducted tests with other radio amateurs, and often, after tiring of speech tests, he put on phonograph records. Soon requests came in from amateurs
(Continued on page 18)

NOVEMBER, 1940

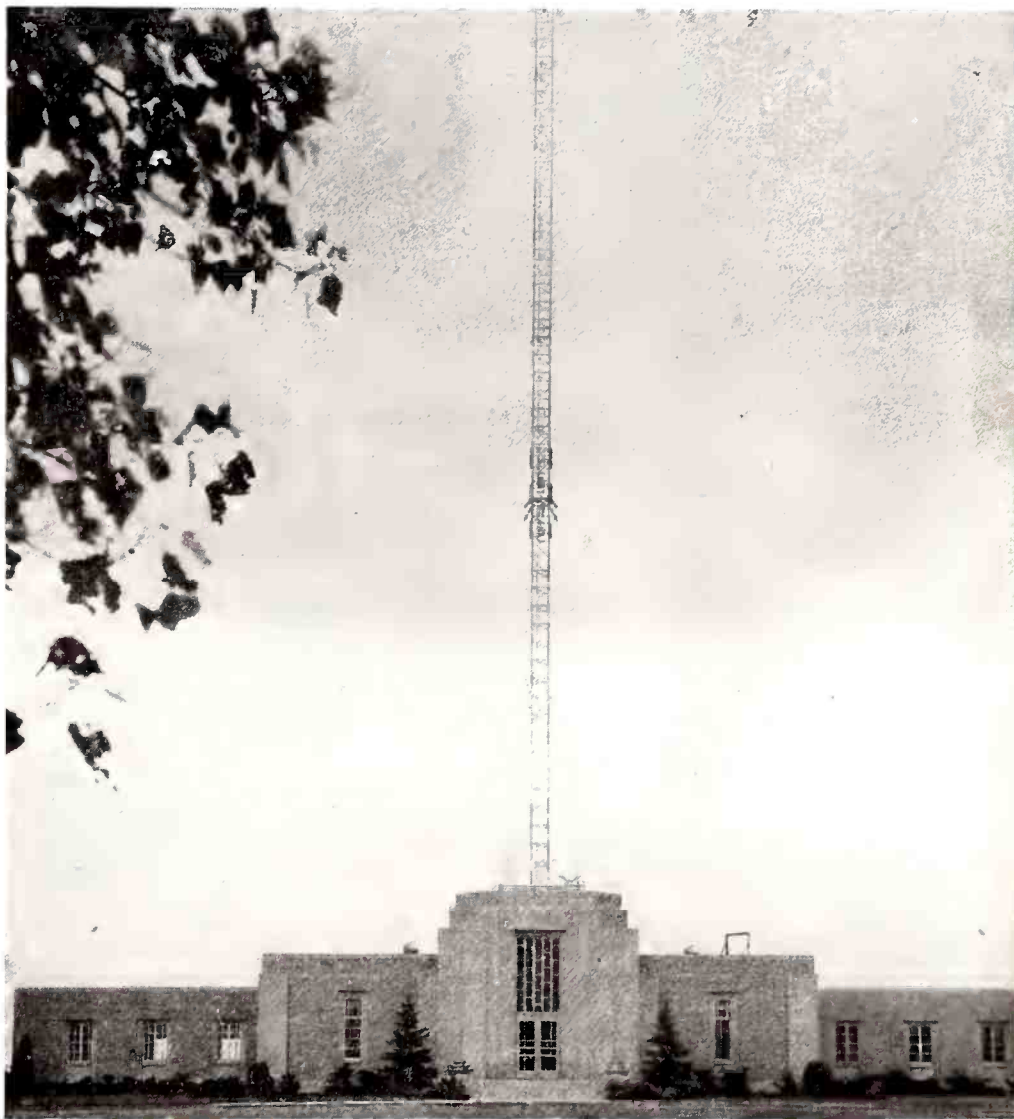

1940

WWJ's big transmitter, illustrating advances since 1920, when 13 stations report they began broadcasting. These were KDKA, KOB, WRR, KLZ, WWJ, WHA, WCAL, WKY, KQV, KQW, KHQ, WDZ and WBAA,—with KDKA and WWJ favored as firsts.

KDKA's studio during the historic Harding Election broadcast of Nov. 2, 1920. The transmitter was located on the Westinghouse plant at Pittsburgh, which also marketed the first broadcast receivers.

1920



TWENTY YEARS OF RADIO: AN AMAZING STORY

Compiled for broadcast Nov. 15 over NBC network from plans being given New York City, in "Radio Night" series by Editor Caldwell of Radio Today.

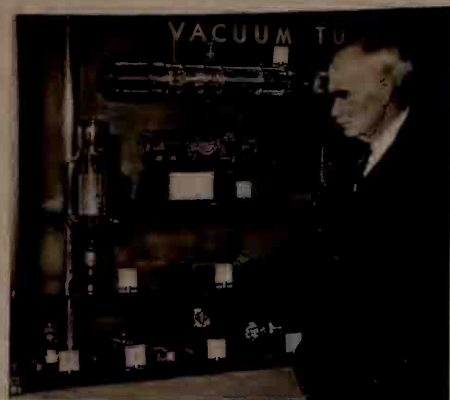

Dr. Lee deForest inspects his early audions (bottom shelf, left)

It was in 1920, just 20 years ago, that the first regular radio program went on the air, and an unfamiliar word—"broadcasting"—was first applied to the new art of sending music, speeches and drama through the air, to people sitting comfortably at home and "listening in."

But while 1920 marks the launching of radio broadcasting as we know it today, there were long years of discovery and invention ahead of that—years of painstaking work that laid the foundations for the glorious 20 year period we now celebrate.

It was just a hundred years ago, at Princeton, N. J., that Joseph Henry, pioneer American scientist, sent the first wireless signal between two antennas 400 ft. apart on the Princeton College campus. He had no way to detect his signal in his receiving antenna except to have the current magnetize a steel needle.

EDISON'S "BLACK BOX"

Also in New Jersey, at Menlo Park, in the eighties, Thomas Alva Edison, while working on his incandescent electric light, discovered the Edison Effect, the faint phenomenon of electron emission which underlies all radio and electronic tubes. It was at Menlo Park, too, that Mr. Edison had as early as 1879 carried on his famous "black box" experiments producing "etheric force" as he called it

ing, soon succeeded in sending messages 200 miles.

Coming to America in 1899, Marconi set up the first wireless station operated in this country, at the Highlands of Navesink, near Sandy Hook. There, by the use of a signal mast normally used for flag signals by the U. S. Coast Guard, Marconi communicated from the S.S. Ponce when he reported the international yacht races in 1899. The Marconi Wireless Telegraph Company of America, forerunner of the present RCA, was formed in that same year, and in 1901 the first permanent wireless station in the U. S. was erected by that company, at Babylon, L. I. This primitive structure is still extant, and stands beside its huge modern brothers at Rocky Point, Port Jefferson, N. Y.

It was at the close of the same year, 1901, that Marconi again made history, when at St. John, Newfoundland, he sent up a kite antenna, by means of which on December 13, 1901, he heard the letter S (three dots), transmitted 2500 miles across the Atlantic, from the Marconi sending station at Poldhu, England.

Looking northward over Manhattan, one can see, up along the Harlem

—or radio-frequency currents as we know them today. This method of producing tiny sparks in a hooded black box on the opposite side of the room, was exhibited at the Paris Exposition in 1881, and closely resembled the famous Hertz oscillator which Hertz announced in 1887 and which is generally viewed as the starting point of all experiments on the propagation of radio signals through space.

But Edison was too hazy with his myriad other inventions, to follow up these two pioneer sallies into the future radio field. Indeed it is doubtful if at the time he realized the future relationship of these two cornerstones of the new art. He merely jotted them down in his crowded notebook and so the next chapters of radio history came from abroad.

MARCONI'S SIGNALS

In Italy, in the nineties, young William Marconi experimented in his home garden with principles previously enunciated by Clerk Maxwell and by Heinrich Hertz, and succeeded in sending signals 1500 ft. Later Marconi went to England and with Sir Oliver Lodge, who suggested tun-

The original superheterodyne receiver is shown here with its inventor, Major Edwin H. Armstrong, who has recently made more radio history by developing FM.



RADIO TODAY

River, Hightbridge, the site of the laboratory of Lee de Forest, who in 1906 took the Fleming valve detector, based upon the famous "Edison Effect," and by adding a grid, made it capable of performing all the wonders of the modern radio tube. A small electrical force put on this grid is able to control the flow of tremendously larger electrical forces flowing across the vacuum in the form of streams of electrons—very much as a child can turn a switch that will start or stop a huge electric locomotive.

So with the invention of the three-element tube, both a sensitive detector and a powerful amplifier were made available to pick up feeble incoming radio impulses.

In the middle distance, on Morningside Heights, we glimpse the buildings of Columbia University, where the young Edwin H. Armstrong, pupil of Prof. Michael Pupin, experimented with the regenerative receiver and other radio circuits.

ARMSTRONG'S INVENTIONS

It was at Columbia University that young Armstrong built his second superheterodyne receiver—the first of which had been put together with sweat and hard toil on the battlefields of France—and at Columbia also he designed and built his first super-regenerative receiver, and his first frequency-modulation apparatus. His first frequency-modulation station was at the Amakassin Club, in Yonkers, directly across from Armstrong's present huge station at Alpine, N. J.

And below us, as we fly, is the Metropolitan Opera House, from a rooftop room of which Dr. deForest on January 13, 1910, broadcast the voice of Caruso to the S.S. Ancon at sea and to an audience of perhaps fifty listening experimenters scattered over the New York area. Thus, 30 years ago, occurred experiments on this first of Metropolitan Opera broadcasts which now mean so much to the NBC audience of many millions.

KDKA'S FIRST BROADCAST

KDKA's first broadcast of election returns in the Harding contest of November, 1920, has been generally accepted as one of the milestones of radio, but there lay behind KDKA a number of years of broadcast experimentation by Dr. Frank Conrad, assistant chief engineer of the Westinghouse company. In his garage laboratory, Dr. Conrad had for years conducted tests with his other radio amateurs, and often, after tiring of success tests, he put on phonograph records. Soon requests came in from amateurs

(Continued on page 18)

NOVEMBER, 1940



1940

WWJ's big transmitter, illustrating advances since 1920, when 13 stations report they began broadcasting. These were KDKA, KOB, WRR, KLZ, WWJ, WHA, WCAL, WKY, KOV, KOW, KHQ, WDW and WBAA—with KDKA and WWJ favored as firsts.

KDKA's studio during the historic Harding Election broadcast of Nov. 2, 1920. The transmitter was located on the Westinghouse plant at Pittsburgh, which also marketed the first broadcast receivers.

1920



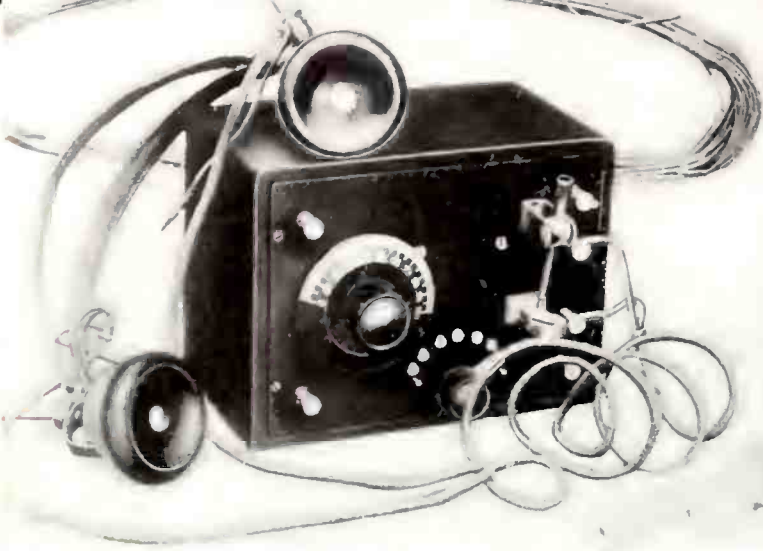

Crosley model No. 1 was this crystal detector supplied with headphones, and antenna parts. Tapped variometer tuning.

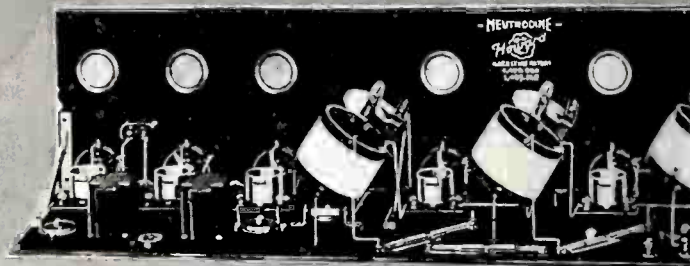

Howard model A5, early 1921 Neutrodyne, used five tubes which could be observed through the screened portholes in the panel. Nine coils.

LISTENING ACROSS

Two-tube Crosley model VI had RF and detector. Two 22½-volt "B" units.

Console-type set of 1922 built by Westinghouse used WD11 tubes and lever type single tuning control. Battery operated. Price with stand, \$350.



RCA portable of 1926 weighed 60 pounds. Loop in front cover. Six tubes. Price, \$225 with home unit for larger batteries.





Stromberg-Carlson set with Neutrodyne circuit and famous "goose magnetic speaker. RF and detector stages were individually tuned.

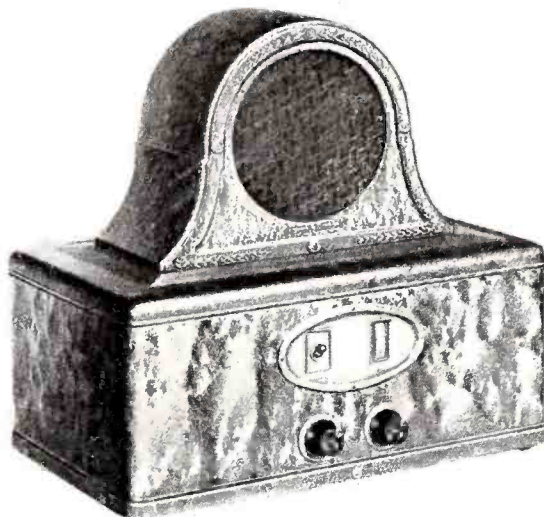

Early AC-operated receiver was this Stewart-Warner model 802. Seven tubes. Power-line aerial. \$110.50.

THE YEARS

A GE receiver of 1923 being used by a farm family. Note rotative loop antenna and goose neck speaker which could be plugged into different audio stages.

Six-tube superhet of 1925, a Radiola 25. Single control tuning. Price \$165 with tubes.

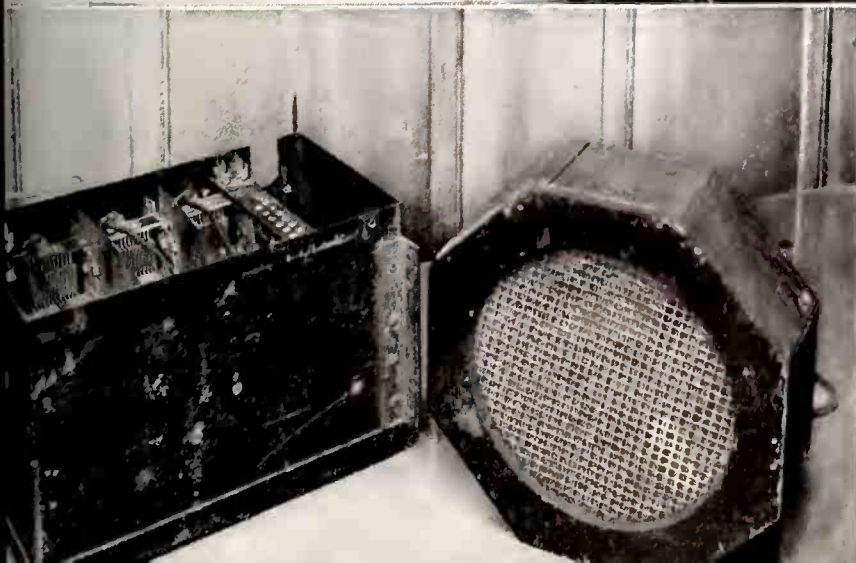
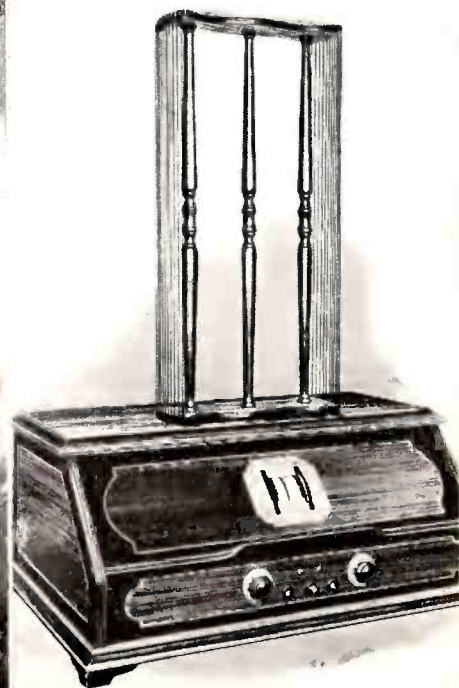

First commercially-built auto radio by Motorola in 1930. Set had separate B batteries. First self-contained auto set introduced in 1932.



Crosley model No. 1 was this crystal detector supplied with headphones, and antenna parts. Tapped variometer tuning.



Howard model A5, early 1921 Neutrodyne, used five tubes which could be observed through the screened portholes in the panel. Nine controls.



Early Stromberg-Carlson set with Neutrodyne circuit and famous "goose neck" magnetic speaker. RF and detector stages were individually tuned.



Early AC-operated receiver was this Stewart-Warner model 802. Seven tubes. Power-line aerial. \$110.50.

LISTENING ACROSS THE YEARS

Two-tube Crosley model VI had RF and detector. Two 22½-volt "B" units.

Console-type set of 1922 built by Westinghouse used WD11 tubes and lever type single tuning control. Battery operated. Price with stand, \$350.

A GE receiver of 1923 being used by a farm family. Note rotative loop antenna and goose neck speaker which could be plugged into different audio stages.

Six-tube superhet of 1925, a Radiola 25. Single control tuning. Price \$165 with tubes.



RCA portable of 1926 weighed 60 pounds. Loop in front cover. Six tubes. Price, \$225 with home unit for larger batteries.



First commercially-built auto radio by Motorola in 1930. Set had separate B batteries. First self-contained auto set introduced in 1932.

The Radio Business Today—Its Magnitude in Its 20th Year

	Total Investment	Annual Gross Revenue	Number of Employees	Annual Payroll
Radio manufacturers (1,064)	\$ 50,000,000	\$300,000,000	75,000	\$ 80,000,000
Radio distributors, dealers, etc.	\$350,000,000	\$600,000,000	150,000	\$225,000,000
Broadcasting stations (862)	\$ 80,000,000	\$185,000,000	20,000*	\$ 50,000,000
Commercial communication stations	\$ 35,000,000	\$ 20,000,000	10,000	\$ 4,000,000
Listeners' sets (50,000,000)	\$3,200,000,000			\$220,000,000†

* Regular staff—not including part-time employees, artists, etc. who number at least 25,000 more.

† Annual operating expense for listeners' sets, for tube replacements, electricity, batteries, servicing, etc.

(Continued from page 15)

that particular records be played at special times, so friends could hear.

Finally in self-defense Dr. Conrad announced that he would "broadcast" records at 7:30 p.m. for two hours every Wednesday and Saturday evening. Later he spiced his programs with vocal and instrumental talent. Soon a Pittsburgh department store began advertising receiving sets that could pick up Dr. Conrad's broadcasts. H. P. Davis, Westinghouse vice-president, quickly saw the possibilities in the idea, and shortly KDKA was authorized by the electrical corporation and the Westinghouse company was also in the market with the first "broadcast receivers."

SOME RADIO "FIRSTS"

From Station WWJ, Detroit, come claims that its predecessor station, operated by W. J. Scripps, was on the air with regular news broadcasts as early as August 20, 1920, and that from this date regular daily broadcasts were maintained both day and night, including news announcements of a local primary election, Aug. 31, 1920. These facts were reviewed in detail during a celebration of the station's 16th anniversary, Aug. 20, 1936, when Dr. Lee deForest was present and spoke on early broadcasting days. In a letter to the *N. Y. Times*, Lee A. White of the WWJ staff, insists that his station was in regular operation 74 days before the classical Harding election broadcast of KDKA, Nov. 2, 1920.

WJZ, Newark, N. J., was the first broadcasting station in the N. Y. metropolitan area. WJZ holds several historic "firsts." It was from WJZ on Oct. 1, 1921, that the first World's Series baseball game was broadcast.

"YANKEE NETWORK"

It was in 1923 that WEAJ was linked to WNAC of Boston for the first network broadcast in history. This was inspired by John Shepard 3rd, who had opened WNAC as the pioneer station in Boston in 1922 and was to initiate many "firsts" in New England.

Mr. Shepard was thus beginning 18 years of aggressive radio development in the New England area, where he started the first regional network

of the country. Then, also, with far-seeing vision, he distinguished himself by accenting the useful and "public service" aspects of radio programs, pioneering in a point of view later to be generally accepted by all broadcasters in formulating their public-relations policies.

Mr. Shepard, in addition to heading the Yankee and Colonial radio webs, is now developing the first network for frequency modulation. He's the president of FM Broadcasters, Inc., and last year was credited with the first FM station, WIXOJ, to go on a 16-hour daily schedule.

NBC AND CBS FORMED

And down amid the lights of the financial district is the first home of NBC at 195 Broadway, which it took over when formed in 1926. Soon afterward the broadcasting company moved to more elaborate studios specially built for it on several floors at 711 Fifth Avenue. And in 1935, the NBC studios and offices were moved



John Shepard, III, president Yankee Network, who achieved many firsts in the Boston and New England area, including the first chain hook-up in 1923. He is now prime mover in FM Broadcasters, Inc.

to Radio City in the Rockefeller Center development.

The Columbia Broadcasting System was organized on its present basis in 1929, and shortly moved into its present building at 485 Madison Avenue, New York City.

The New York City skyline is filled with other radio memories. The low-lying Battery Park has its Wireless Operators' Monument, dedicated to the radio men who have lost their lives at their posts of duty.

RADIO MEMORIES

And then down there on 39th Street, in the Engineer's Auditorium used by the Institute of Radio Engineers, Marconi and other radio leaders have many times addressed the radio men of New York and the country. This hall, too, has echoed to the voices of Alexanderson, Austin, Baker, Ballantine, Beverage, Cady, Farnsworth, Fessenden, Goldsmith, Heising, Hogan, Kellogg, Langmuir, Miessner, Pickard, Pierce, Rice, Zworykin, and others.

And down there too are the dark shadows of the Madison Square Garden and Grand Central Palace, filled with memories of many radio shows which introduced to the public the crowding new developments in the radio art, as these rapidly made obsolete the sets that had gone before.

New York City's buildings thus form almost a series of milestones of the radio progress of the past.

FUTURE POSSIBILITIES

But others of New York's pinnacles point to the future, for here are the Empire State Tower and Chrysler building with their television transmitters and promises of new services. New developments in short waves and micro waves now are ready to leave the laboratory and go into commercial application. Newspapers and magazines actually printed in the home by radio, represent one such new development, which is technically complete but waits for big-scale commercial experiment.

Millions of radio channels still await use down in the ultra-short-waves. In fact, radio men envisage a day to come when every citizen in even a huge metropolis of 7 or 8 million like New York will have his own

personal radio wavelength all to himself. So if I want to call a friend, I will simply pull out of my pocket my little portable transceiver, set it on "Channel 6,348,492," and he and I will be able to start talking.

Big things are ahead for radio. This month radio completes a wonderful 20 years of past progress. But *ahead* is a 20 years with even more startling advances in sight!

Early Days with Stromberg-Carlson Radio

"First let me commend RADIO TODAY for this splendid thought of a Twentieth Anniversary of Radio Broadcasting," comments Lee McCanne, assistant general manager of Stromberg-Carlson Telephone Manufacturing Company, Rochester, N. Y.

"I believe we are the only telephone manufacturer in the world who makes home-type radio receivers. Telephone laboratories have contributed so much to the basic principles of radio broadcasting, chain network operation, radio receivers, and electrically-recorded and reproduced phonograph records, that this unique position is all the more remarkable.

"It was quite natural that our company was called upon to make some headsets for the Navy in 1915, which marks the real start of our radio experience. Our headset sales continued over a period of years in very small volume until KDKA started the broadcasting craze. Immediately there was a terrific demand for headsets, and soon distributors and selling agents began arriving at our doorstep with certified checks, hoping to take carloads of headsets away with them, regardless of all prior orders or commitments.

280,000 HEADSETS!

"These orders pyramided rapidly. Mr. Angle, our president, loves to tell the story of how within a few weeks we had orders for 280,000 headsets; we made up 70,000 headsets and managed to ship 35,000 of these before the bottom dropped out of the market. It took several years to work off the rest of them as initial equipment with our receiving sets.

"In the meantime, we had developed a horn-type loudspeaker which found a ready market with the radio receiving-set manufacturers of that day, and our telephone repeater-coil experience with special magnetic alloys, enabled us to develop audio transformers which had pretty good tone quality. If you will remember back to that time, manufacturers were coming into radio from the phonograph, piano, automobile ignition, battery and electric power equipment fields. Our No. 3-A audio transformer became famous, and our telephone-type by-pass condensers were used in several brands of radios. With such a background no wonder we started off on a basis of tone quality.

"It was not until Professor Hazeltine showed the way to a distortionless circuit free from the audio troubles of the old Armstrong regenerative, however, that we produced our No. 1-A receiving set in 1924. And a little later we again set the pace and quality with the first totally-shielded radio, our No. 601-A."



Austin C. Lescarboua, public-relations counsel of Croton-on-Hudson, N. Y., shown in early radio days. Later he edited *Popular Science* and *Scientific American*, and wrote the books "Radio for Everybody" and "This Thing Called Broadcasting."

Army-Navy Musical Broadcast of 1908-09

How the U. S. Army and Navy staged one of the earliest radio broadcasts of phonograph music in history, is recounted by Austin Lescarboua, veteran radio man, science editor, and public-relations counsellor, of Croton-on-Hudson, N. Y.

"One of those long, cold, discouraging winters was 1908-9," writes Mr. Lescarboua. "An evening student at an engineering school, I had landed a daytime job with the Telefunken Wireless Telegraph Company of America. The work was really fun, for it permitted me to pursue my wireless hobby

Engineer Behind 15 Million Philcos



William H. Grimditch, vice-president in charge of engineering for Philco, which this month celebrates its 15th million receiver, an all-time high for any manufacturer.

on a grand scale, as compared with my less fortunate friends of the air.

"By December we were unpacking a collection of giant wooden cases containing a complete wireless telephone! This was a duplicate of the outfit demonstrated before the German army, for accomplishing two-way wireless telephony over a distance of 60 miles. At least that was the story sent along with this equipment—though never equalled or confirmed by our replica.

"I was entrusted with getting the equipment down to Fort Hancock—Sandy Hook to you—and setting it up in the wireless station behind the big disappearing guns. Weeks were required to reassemble and test the miscellaneous pieces of equipment, including the American addition, a 7½-hp Crocker-Wheeler motor-generator to convert the post's 110-volt D.C. into 550 volts D.C..

RADIO ON—LIGHTS OFF!

"Among the things to be worked out was some sort of collaboration throughout the post, whereby enough electric lights were turned off so we could have the necessary current to operate our big motor-generator. Especially so when starting up in zero weather, with frozen grease in the bearings.

"Came the day when our wireless telephone went on the air. The ten series-connected arcs, struck between large carbon buttons and water-filled copper cans, produced the required oscillations. The whole thing looked like a pipe organ, with sputters and sizzlings thrown in. Our microphone was a flat cartridge affair placed in a socket at the base of a huge fibre horn, and readily replaceable with a fresh cartridge. One of my assistants had the job of removing the horn, taking out the baked microphone with a pair of pliers, and slipping another cartridge in place. With good luck a microphone cartridge might last for several minutes before the carbon granules became thoroughly baked and our modulation meter indicated no further microphone action.

MIKES GO UP IN SMOKE

"We worked hard in those tests. The prize was a \$25,000 contract to be awarded by the U. S. Signal Corps for the first equipment handling wireless telephonic communication for five minutes or more, between Fort Hancock (Sandy Hook) and Fort Wood (Bedloe's Island, in the shadow of the Statue of Liberty). We shouted test numbers into the horn; we shouted instructions; we acknowledged messages flashed back to us by wireless telegraph and picked up by the Signal Corps operator alongside. But most of the time we made use of an Edison phonograph and a collection of cylinders selected for outstanding volume. The morning-glory horn of the phonograph was placed right into the microphone horn, so that no precious volume might be lost.

"BUT PLEASE, CHANGE THAT TUNE!"

"One day I had been playing the phonograph by the hour. We had used up on an average of half a dozen microphones per hour, at \$4. each. Our best record, as selected by the modulation meter, was the *Anvil Chorus* from *Il Trovatore*. Suddenly the wireless op-

(Continued on page 33)

F. Q. S. Andrews

ATWATER KENT

EVEREADY

MUTER

MAGNAVOX

**AUDAX
BRACH**

Fleron

SICKLES

PHILCO

Stromberg-Golson

BRIGHTSTAR

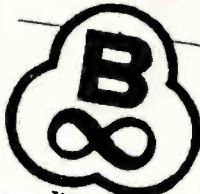

FRENCH RAY-O-VAC
Radio's Best Batteries

Sylvania

Freed-Eisemann



Sterling

COTO-COIL

GENERAL ELECTRIC



GENERAL RADIO CO

Stewart-Warner Radio

CROSLLEY

Hammarlund

HOWARD

SPARTON

CROWE

HYTRON

RAYTHEON

TRIMM

**DUBILIER
CONDENSER
CORPORATION**

**JEFFERSON
TRANSFORMERS**

UTAH
Made in Salt Lake City
Trade Mark Registered

KEN-RAD

WIRT COMPANY

EBY
PATENTED

NEUTRODYNE
LICENSED BY
INDEPENDENT RADIO MANUFACTURERS, INC.
REG. U.S. PAT. OFF. MAR. 27 1923 AND APRIL 1 1924
TRADELINE PATS. NOS. 1450,000 AND 1489,228
OTHER PATENTS PENDING

Westinghouse

ELKON OPERADIO

WESTON
STANDARD THE WORLD OVER
POWER 115

Emerson

PACENT

YAXLEY

ERLA

Radio Corporation of America

NA-ALD

ZENITH
LONG DISTANCE RADIO

NAMES THAT SHINE IN RADIO HISTORY

*Trade-marks that have come down through the years,
 foundationed on service to industry and public*

In the 20 years since radio broadcasting began, no group of manufacturers has served the public better,—nor done more for the public good,—than have the makers of radio sets, radio tubes, and radio equipment.

And no industry has grown faster. On this and on many other pages of this Twentieth Anniversary Number, are presented the romantic history and present statistical magnitude of the radio business.

It is a business grown literally "from nothing"—until today its total yearly collections from the American public total nearly a billion dollars every twelve months.

A city the size of Detroit, Cleveland or Los Angeles, is dependent on the radio business, if all the workers and wage-earners of the various branches of radio could be gathered together into a single community.

Its products have become a vital center of American life, and have revolutionized the daily routines of countless millions of men, women and children.

FALLEN BY THE WAYSIDE

The record of the radio industry's achievements is today's best proof of that old truism—"He serves his own interests best, who best serves the interests of the public."

In the superlative record of the radio industry, can be found the

names of hundreds of manufacturers who have "come through" with colors flying,—while there are also many more hundreds of names that have "come and gone," fallen by the way-side.

Wise manufacturers and dealers will pause now to look back over the last twenty years and see how quickly those who could not measure up, were forced out of the picture, either by their own choice or by the inexorable pressure of events. Every man in the radio business today can learn therefrom a lesson for his own future prosperity.

The bold message which the radio industry has written on the records of our country in the last 20 years, is a great one.

But it is only the beginning of far greater years to come.

What all the new expansions in higher fidelity, greater compactness, personal and "pocket" radios, frequency modulation, international broadcasts and television may bring in the future, no man can now say.

The future of radio bulks so large as to seem fantastic.

ROLL CALL

Radio Industry, November, 1940

Manufacturers of radio receivers . . .	82
Manufacturers of radio tubes	10
Manufacturers of radio parts	700
Manufacturers of test equipment . . .	49
Manufacturers of broadcast and amateur equipment	95
Manufacturers of sound equipment . .	106
Radio-set and parts distributors . . .	2,150
Manufacturers' agents	301
Retail outlets selling radios	57,000
Servicemen, including dealers' servicemen	25,000
Radio amateurs and experimenters .	90,000



U. S. homes with radio	29,200,000
"Secondary" sets in above homes	12,200,000
Battery portables	1,400,000
Auto radios	7,200,000
Total radios in use	50,000,000

MUST BUILD SOUNDLY

However greater the next twenty years may be than the last twenty, of this we can be sure—the underlying basis of business success will be unchanged.

Tomorrow it will still be,—as today it is, and yesterday it was,—foundationed on the axiom that "He serves his own interests best (i.e., profits most), who best serves the interests of the public."

WEBSTER-CHICAGO

National Union

Halldorson

Majestic
NIGHTY MONARCH OF THE AIRS

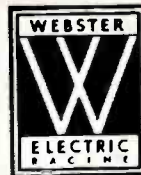

BURGESS

TRIPLET

Sonora



Centralab

GALVIN

OHMITE

Belden

THORDARSON
Elec. Mfg. Co.

Jensen

Readrite

SHURE



F.P.G.

They're headed for your store! Have you made all the last-minute preparations for holiday business?

Radio is twenty years old, as we know it, this month.

More radio will be sold this year than ever before.

More radio will be sold this October, November and December, than in any similar period since broadcasting began.

When business is good many of us are likely to let down on the little things, and to neglect some of the primary principles which translates good business into good profits.

Dealers should not forget that the profit of many good sellers rides on the few sets which don't sell.

That is particularly important this year. Turnover is a vital ingredient in the recipe for profits.

And from now 'til Christmas is the best time of all the year to turn the pressure on the slow movers, the "cats and dogs" which have been accumulating through the year's operation.

From the great department stores we can learn an important lesson in Christmas merchandising.

When more people are buying more things than during any other period

of the year, these great merchandising organizations watch their stock movement the closest.

At least twice during the Holiday season a special check-up of slow moving stock is made.

GET STARTED

On the first check, it is made certain that all slow moving stock is given better display attention, so that it may be more attractive to more people. Prices are reduced to a point where it should be snapped up fast as a bargain, for anything can be sold to someone, if the price is right.

About two weeks before Christmas another check is made, and the results of the special displays, suggestive selling, and price reductions are carefully noted.

If the movement of this merchandise has not been speeded up to a satisfactory degree, further price reductions, still better displaying, still more aggressive selling are ordered.

The profits of many a radio dealer's year's operation lies dormant and

sunk, in the slow or non-moving stock he has accumulated.

Models which for some reason the public has not taken a fancy to, are the hard ones to sell, and become the "profit eaters." In every radio line, and in every dealer's store there are many of these.

The usual reason for their presence in a line is that other models are styled more to the public taste, look like better values. Not that there is anything really wrong with the model in question.

And the principal reason these models stay in the dealer's stock are: First, he has found it so much easier to sell other models, which people seem to like better, that he has finally stopped trying to sell them.

Second, he has had the set around so long, and failed to sell it, he begins to think there is something wrong with it.

Third, there may be something wrong with the particular model on display which places it as a disadvantage under demonstration.

FIVE THINGS TO DO

But a few simple, though important steps can be made to turn this non-moving stock into dollars in the bank.

First, of course, is to check your stock carefully, and know just what is moving and what is not moving.

Second, examine your floor models of the non-moving sets, and make certain that they are in the best possible mechanical and electrical condition, that they are clean, polished, and otherwise in prime selling condition.

Third, display them prominently, with signs to call attention to their selling and operating features.

Fourth, price them right, and put a special tag, a red, or blue, or green "Christmas Special" price tag on them, to attract particular attention to them.

Fifth, instruct all salespeople in the selling features of these sets, with orders to show them to everyone, and sell them to someone.

PROVEN METHODS

To give the salespeople a little more incentive to sell them, an extra commission helps a lot.

A double, or triple guarantee, goes a long way in impressing the customer with your belief in the set, and with your selling sincerity.

This is often the deciding factor in making the sale.

Long experience has proven that if these five steps are properly taken, your slow moving merchandise will move out. Whether your problem remains solved is up to you.

When this slow moving merchan-

CHECK ON XMAS SELLING

dise begins to move under this special effort, don't make the mistake of thinking it has become fast moving, and buy more to meet what you think is a new demand.

It is best to buy *no more* of these models, unless, at the price at which you *know* you can sell them, you can make your full margin, through a longer discount from your distributor.

And even then you should be conservative, for the better price *you* get *others* too, will get and some cut-price advertising may be expected to soon take the play away from you.

EFFECTIVE DISPLAY

In Christmas merchandising, when the salesforce is seldom able to give immediate attention to everyone, store display is a more important factor than at other more normal seasons, though many dealers really neglect their displays at this season of the year.

Christmas displays of *all* radio will do a better selling job if the primary features of each set are shown on a sign, a card, or a large price tag, on each set.

Prospective customers can then inform themselves to a large extent while all salespeople are busy, save a great deal of selling time.

"Sales per person," the result of saving selling time, are very important in Christmas profits, because the percentage of your store traffic which are "lookers" is much higher at this season.

To have a salesforce large enough to give immediate personal attention to everyone who visits your store during the holidays would send selling costs sharply up.

STRAIGHTFORWARD POLICY

This informative, or selling type of display, will not only do the work of several salespeople, and reduce your peak selling expense, but it also looks better, does a better selling job, and reflects more credit to you and your store.

Occasionally some dealer objects to putting full information where the public can see it, and compare.

It eliminates their own hocus-pocus in selling.

Such viewpoints are a throwback to the days of "caveat emptor" (let the buyer beware) which have no place in modern merchandising.

Today, to build your business on a solid foundation, and insure its lasting success, hocus-pocus is *out*.

You must sell your products honestly.

Serve your customers faithfully.

Cultivate satisfaction and good-will sincerely.

The policies of your business, your methods of selling and serving, should be as open and as capable of advertising as the merits of the products you sell.

Most people prefer to sell themselves than to be sold by another.

The great mail-order chains, and the five and tens, have used this psychological fact, as shown by their wide open, informative type of displaying, to both increase their sales, and to reduce their expense.

Most dealers could much improve their own store, and reduce their costs, if they would look with unbiased and thoughtful eyes, at the displays, and the methods of their local Sears or Montgomery Ward stores, with the thought of copying what is best in them, and beating them where they are most vulnerable.

Radio Men Get Together for Liveliest "Radio Xmas"

As radio men now search for new methods for making this a bigger and better "Radio Christmas" the trade looks with interest to what happened last Christmas among dealers and distributors in Pittsburgh, Pa.

In that city, a five-way cooperative plan was worked out among servicemen, distributors, stations, a newspaper, and a charity agency, in a highly commendable effort to get old sets out of the hands of donors and into the homes, as Christmas gifts,

of those who could not afford to buy them. Result: sets totalling 1,446 (the goal was only 500) were offered by the public.

RUNS TWO WEEKS

Stations KDKA, WWSW, KQV, and WJAS and the Pittsburgh *Post-Gazette* opened the appeal on Dec. 12 and continued with special programs and announcements. Sets were taken to "Santa's Radio Workshop" which was a gayly decorated affair operating in full view of the public, for repairing, before they were turned over to the Federation of Social Agencies, who supervised their distribution among needy people. Trucks from the newspaper, and those of the Pittsburgh Milk Co. picked up the sets. RSA contributed 1,000 tubes, in addition to voluntarily working at night at "Santa's Radio Workshop." Eighteen radio jobbers supplied funds to pay unemployed servicemen to help fix the sets.

The total upshot of Pittsburgh's "Radio Christmas" besides the enormous good will it created was that: hundreds of worthy needy families got an important radio gift; the stations and the newspaper were credited with a distinguished charity enterprise; hundreds of old sets disappeared as market factors; servicemen got better acquainted with the public; dealers found out where new, extra sets might be sold; extra jobs were created.

A Christmas stunt at Kuss Bros., Hackensack, N. J., shows a dramatic contrast between old and new radio values. At left, a 1928 job; right, a sleek 1940 unit.



FINAL CHECK ON XMAS SELLING



F.P.G.

They're headed for your store! Have you made all the last-minute preparations for holiday business?

Radio is twenty years old, as we know it, this month.

More radio will be sold this year than ever before.

More radio will be sold this October, November and December, than in any similar period since broadcasting began.

When business is good many of us are likely to let down on the little things, and to neglect some of the primary principles which translate good business into good profits.

Dealers should not forget that the profit of many good sellers rides on the few sets which don't sell. That is particularly important this year. *Thereover* is a vital ingredient in the recipe for profits.

And from now 'til Christmas is the best time of all the year to turn the pressure on the slow movers, the "cats and dogs" which have been accumulating through the year's operation.

From the great department stores we can learn an important lesson in Christmas merchandising.

When more people are buying more things than during any other period

of the year, these great merchandising organizations watch their stock movement the closest.

At least twice during the Holiday season a special check-up of slow moving stock is made.

GET STARTED

On the first check, it is made certain that all slow moving stock is given better display attention, so that it may be more attractive to more people. Prices are reduced to a point where it should be snapped up fast as a bargain; for anything can be sold to someone, if the price is right.

About two weeks before Christmas another check is made, and the results of the special display, suggestive selling, and price reductions are carefully noted.

If the movement of this merchandise has not been speeded up to a satisfactory degree, further price reductions, still better displaying, still more aggressive selling are ordered.

The profits of many a radio dealer's year's operation lie dormant and

sunk, in the slow or non-moving stock he has accumulated.

Models which for some reason the public has not taken a fancy to, are the hard ones to sell, and become the "profit eaters." In every radio line, and in every dealer's store there are many of these.

The usual reason for their presence in a line is that other models are styled more to the public taste, look like better values. Not that there is anything really wrong with the model in question.

And the principal reason these models stay in the dealer's stock are: First, he has found it so much easier to sell other models, which people seem to like better, that he has finally stopped trying to sell them.

Second, he has had the set around so long, and failed to sell it, he begins to think there is something wrong with it.

Third, there may be something wrong with the particular model on display which places it as a disadvantage under demonstration.

FIVE THINGS TO DO

But a few simple, though important steps can be made to turn this non-moving stock into dollars in the bank.

First, of course, is to check your stock carefully, and know just what is moving and what is not moving.

Second, examine your floor models of the non-moving sets, and make certain that they are in the best possible mechanical and electrical condition, that they are clean, polished, and otherwise in prime selling condition.

Third, display them prominently, with signs to call attention to their selling and operating features.

Fourth, price them right, and put a special tag, a red, or blue, or green "Christmas Special" price tag on them, to attract particular attention to them.

Fifth, instruct all salespeople in the selling features of these sets, with orders to show them to everyone, and sell them to someone.

PROVEN METHODS

To give the salespeople a little more incentive to sell them, an extra commission helps a lot.

A double, or triple guarantee, goes a long way in impressing the customer with your belief in the set, and with your selling sincerity.

This is often the deciding factor in making the sale.

Long experience has proven that if these five steps are properly taken, your slow moving merchandise will move out. Whether your problem remains solved is up to you.

When this slow moving merchandise

begins to move under this special effort, don't make the mistake of thinking it has become fast moving, and buy more to meet what you think is a new demand.

It is best to buy no more of these models, unless, at the price at which you know you can sell them, you can make your full margin, through a longer discount from your distributor.

And even then you should be conservative, for the better price you get others too, will get and some cut-price advertising may be expected to soon take the play away from you.

EFFECTIVE DISPLAY

In Christmas merchandising, when the salesforce is set on sale to give immediate attention to everyone, store display is a more important factor than at other more normal seasons, though many dealers really neglect their displays at this season of the year.

Christmas displays of all radio will do a better selling job if the primary features of each set are shown on a sign, a card, or a large price tag, on each set.

Prospective customers can then inform themselves to a large extent while all salespeople are busy, save a great deal of selling time.

"Sales per person," the result of saving selling time, are very important in Christmas profits, because the percentage of your store traffic which are "lookers" is much higher at this season.

To have a salesforce large enough to give immediate personal attention to everyone who visits your store during the holidays will send selling costs sharply up.

STRAIGHTFORWARD POLICY

This informative, or selling type of display, will not only do the work of several salespeople, and reduce your peak selling expense, but it also looks better, does a better selling job, and reflects more credit to you and your store.

Occasionally some dealer objects to putting full information where the public can see it, and compare.

It eliminates their own hocus-pocus in selling. Such viewpoints are a throwback to the days of "caveat emptor" (let the buyer beware) which have no place in modern merchandising.

Today, to build your business on a solid foundation, and insure its lasting success, hocus-pocus is out.

You must sell your products honestly.

Serve your customers faithfully. Cultivate satisfaction and good-will sincerely.

The policies of your business, your methods of selling and serving, should be as open and as capable of advertising as the merits of the products you sell.

Most people prefer to sell themselves than to be sold by another. The great mail-order chains, and the five and tens, have used this psychological fact, as shown by their wide open, informative type of displaying, to both increase their sales, and to reduce their expense.

Most dealers could much improve their own store, and reduce their costs, if they would look with unbiased and thoughtful eyes at the displays, and the methods of their local Sears or Montgomery Ward stores, with the thought of copying what is best in them, and besting them where they are most vulnerable.

Radio Men Get Together for Liveliest "Radio Xmas"

As radio men now search for new methods for making this a bigger and better "Radio Christmas" the trade looks with interest to what happened last Christmas among dealers and distributors in Pittsburgh, Pa.

In that city, a five-way cooperative plan was worked out among servicemen, distributors, stations, a newspaper, and a charity agency, in a highly commendable effort to get old sets out of the hands of donors and into the homes, as Christmas gifts,

of those who could not afford to buy them. Result: 266 totaling 1,416 (the goal was only 500) were offered by the public.

RUNS TWO WEEKS

Stations KDKA, WWSW, KQV, and WJAS and the Pittsburgh *Post-Gazette* opened the appeal on Dec. 12 and continued with special programs and announcements. Sets were taken to "Santa's Radio Workshop" which was a gayly decorated affair operating in full view of the public, for repairs, before they were turned over to the Federation of Social Agencies, who supervised their distribution among needy people. Tracks from the newspaper, and those of the Pittsburgh *Mail*, Co. picked up the sets. RSA contributed 1,000 tubes, in addition to voluntarily working at night at "Santa's Radio Workshop."

Eighteen radio jobbers supplied funds to pay unemployed servicemen to help fix the sets.

The total upshot of Pittsburgh's "Radio Christmas" besides the enormous good will it created was that: hundreds of worthy needy families got an important radio gift; the stations and the newspaper were credited with a distinguished charity enterprise; hundreds of old sets disappeared as market factors; servicemen got better acquainted with the public; dealers found out whom new, extra sets might be sold; extra jobs were created.

A Christmas stunt at Kuss Bros., Hackensack, N. J., shows a dramatic contrast between old and new radio values. At left, a 1928 job; right, a sleek 1940 unit.





First radio service station in New York started by Arthur E. Rhine, well known serviceman.



Servicemen Gilbert Clay and Cole Worsham are shown in this ten year old shot of Porter Bennett's shop, Dallas, Texas.

RADIO YESTERDAY

Below, left, is early set analyzer with 8 and 200 volt ranges. For WD11, '99, '01A.

Home service jobs used equipment like this. Tube types were few and testers didn't take Christmas Tree lights.



Lower left. Service shop of several years ago. Time saving features of modern equipment have increased efficiency.



Lower right, 1919 auto installation shows L. G. Pacent and "what the well-dressed auto-radio user wore," 21 years ago!

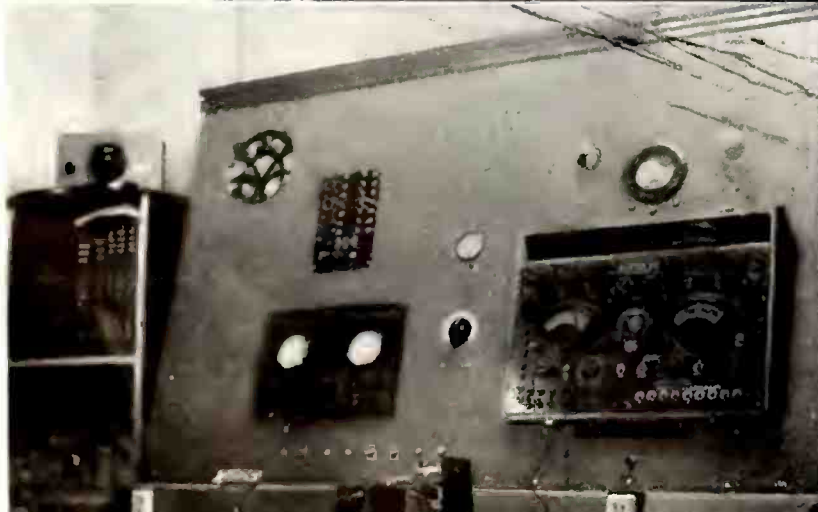

Postal Telegraph Steps up Service to Millions...

Raytheon engineers make an important contribution in overcoming delays caused by adverse weather conditions.

Postal Telegraph's headquarters station in Chicago. One of the largest operating rooms in the world. 28 RAYTHEON units installed here.

By Using

RAYTHEON TUBES

How to save seconds of time! How to counteract interruptions caused by snow, sleet, hail, electric storms and aurora borealis! How to improve service in every way! These are problems constantly before Postal Telegraph executives. Much time and money have been invested to solve them.

In cooperation with them, RAYTHEON engineers developed equipment, incorporating a Postal Telegraph invention, a revolutionary relay unit, in which RAYTHEON tubes play a vital part. These tubes are in constant service, 24 hours day in and day out. With their use, fading electric impulses are picked up, amplified, and messages speeded through faster than was ever before possible where weather is a factor.

Hundreds of these units have already been installed in Postal Telegraph offices throughout its nationwide system and millions of patrons are benefited thereby. During the severe electrical disturbance caused by aurora borealis on Easter Sunday, 1940, while ordinary circuits were disrupted the circuits equipped with RAYTHEON apparatus were unaffected. Thus Postal Telegraph rendered excellent service during a period in which other services were interrupted.

The same engineering genius which helped Postal Telegraph solve one of its baffling problems goes into every tube in the RAYTHEON LINE. That's why RAYTHEONS give such superb service wherever installed. And that's why RAYTHEON service-men and dealers everywhere are building goodwill, bigger business, and bigger tube profits by making replacements with RAYTHEONS.

These RAYTHEON advantages are now open to you . . . benefits you may enjoy with smaller stock of tubes, because you need only one line. For RAYTHEON makes them all . . . and they cost no more! Your RAYTHEON Distributor has an unusual tube deal for you. See him without delay.

One of the RAYTHEON units now standard equipment in hundreds of Postal Telegraph Stations. Note the 4 RAYTHEON Tubes.

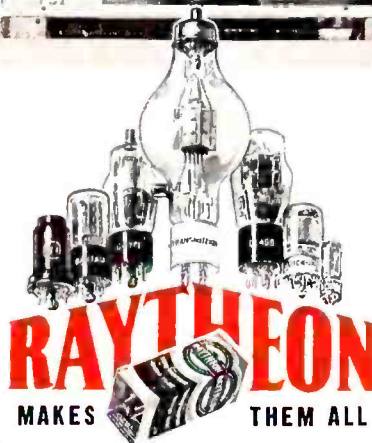

RAYTHEON

MAKES THEM ALL

NEWTON, MASS. NEW YORK CHICAGO
SAN FRANCISCO ATLANTA

WORLD'S LARGEST EXCLUSIVE RADIO TUBE MANUFACTURERS

REFRIGERATOR VOLUME

Fall sales are already up 53%, as models come out earlier and provide more and more of those year 'round profits

Christmas models, and plenty of new refrigerators of special importance to dealers for November-December selling, are now rolling off the production lines.

There is extra activity in the field, and a number of extra reasons why retailers should take prompt action on selling the boxes. The year-end market does not have the same aspects as it had a year ago, and the new theme song is "it's easier to sell."

SPENDING INCREASED

Buying power is up and thousands of additional families now have extra money to spend on home devices. Liberal estimates from Washington indicate that up to 500,000 people per month are getting jobs as a result of the National Defense program.

Dealers will find it profitable to keep a close tab on the factories that are expanding in their areas, and to aggressively promote their refrigerators to the folks who are getting on the payrolls. In many cases these families are modest ones, and they may not want to contract for a \$149 box, right off. But retailers should certainly get them used to the idea of saving money by preserving their family foods properly, so that such an acquaintance with the dealer will (if not now) later result in a sale.

Anyway, many of these people will

Trimmed, priced and promoted for holiday trade, 6½ ft. job.

be around the shopping districts with their eyes on small appliances and small radios. This is a chance for dealers to make a contact and perhaps to be satisfied with a small-unit sale to start with. But a very practical and not-too-insistent suggestion about what the new refrigerators will contribute to their homes will serve to plant some valuable seeds.

These people may remember references and demonstrations on favorite foods, when they forget everything else. For instance, one manufacturer suggests the queries:

"Ever serve three months old meat more tender than it was the day purchased?"

"Ever eat flaky, juicy pie—frozen two weeks ago—baked fresh today?"

These matters have such a direct and tangible relation to the appetite and the well-being of prospects, they make a real impression. Besides, this method of approach gives dealers a chance to emphasize something other than the matter of price.

HOLIDAY TRIMMINGS

Christmas displays are ready and they look like star attractions this year. They have color, action, personalized effects, and they are a great deal more eye-catching and impressive than those trims prepared for small appliances. They are early,

The deluxe 871 with Dual Temp, one of Stewart Warner's 8 new models.

Promotion Head



Sales promotion at Norge will now be headed up by M. W. Thompson, who has been named for the post by the firm's v.p. in charge of sales, M. G. O'Harra.

and there are enough of them to make a dealer's holiday window, by themselves.

This year, additional models are being offered along with "extras," such as clocks or kitchen radios, and this gives dealers a good opportunity to accent the "personal gift" angle.

Another stunt which many dealers are counting on, to increase the effectiveness of their displays during the remainder of 1940, is the use of "dinner spreads" concerned with Thanksgiving and Christmas dinners. After all, one of the most festive aspects of these holidays is the "food" part, and what is more important in the preparation of delicious food, than a new refrigerator? Many retailers are taking this theme for novel displays.

Two more things which dealers will want to give special attention this year are (1) A vigorous and dramatic publicity and promotion campaign on the brand new features of refrigerators, and (2) A clear and practical announcement of the time payment facilities which are now available.



Broadcasting's 20th Birthday with Sensational **ANNIVERSARY OFFER**

on purchase of new 1941

RCA Victrola

with Exclusive Tone Guard!

YOU said: "Give us *another* opportunity like the great RCA Victrola 40th Anniversary Celebration!"

WE say: "Take a look at this new RCA Victrola 20th Anniversary-of-Broadcasting offer!"

Here is the same type of Anniversary Offer that sold thousands of RCA Victrola models for thousands of RCA Victor dealers two years ago! But with this important difference: Today, RCA Victrola values are greater than ever! —public interest in phonograph-radios is more intense than ever—and new 1941 RCA Victrola models offer more *features* than ever for the finest performance ever offered the American public . . . *your* customers and ours!

Make this mental note now: "Get details of RCA Victrola giant trade-in offer from your distributor today!" You'll be mighty glad you did!



Trademarks "RCA Victor" and "Victrola" Reg. U. S. Pat. Off. by RCA Manufacturing Company, Inc.

Victrola

A Service of the Radio Corporation of America

3 people out of every 5 will hear
BROADCAST
messages!



—and 1 in every 3
will see this RCA Victrola
ADVERTISING!

Powerful RCA Victrola advertising in national magazines like The Saturday Evening Post, Collier's, The New Yorker, Time and Esquire, will reach one-third of all Americans!





REFRIGERATOR VOLUME

Fall sales are already up 53%, as models come out earlier and provide more and more of those year 'round profits

Christmas models, and plenty of new refrigerators of special importance to dealers for November-December selling, are now rolling off the production lines.

There is extra activity in the field, and a number of extra reasons why retailers should take prompt action on selling the boxes. "The year-end market does not have the same aspects as it had a year ago, and the new theme song is "it's easier to sell."

SPENDING INCREASED

Buying power is up and thousands of additional families now have extra money to spend on home devices. Liberal estimates from Washington indicate that up to 500,000 people per month are getting jobs as a result of the National Defense program.

Dealers will find it profitable to keep a close tab on the factories that are expanding in their areas, and to aggressively promote their refrigerators to the folks who are getting on the payrolls. In many cases these families are modest ones, and they may not want to contract for \$149, but, right off, but retailers should certainly get them used to the idea of saving money by preserving their family foods properly, so that such an acquaintance with the dealer will (if not now) later result in a sale.

Anyways, many of these people will

Trimmed, priced and promoted for holiday trade, 6½ ft. job.

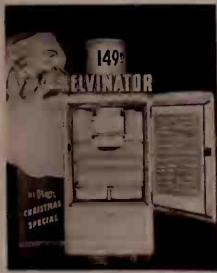

30

be around the shopping districts with their eyes on small appliances and small radios. This is a chance for dealers to make a contact and perhaps to be satisfied with a small-unit sale and not too insistent suggestion about what the new refrigerators will contribute to their homes will serve to plant some valuable seeds.

These people may remember references and demonstrations on favorite meals, when they forget everything else. For instance, one manufacturer suggests the queries:

"Ever serve three months old meat more tender than it was the day purchased?"

"Ever eat flaky, juicy pie—frozen two weeks ago—baked fresh today?"

"These matters have such a direct and tangible relation to the appetite and the well-being of prospects, they make a real impression. Besides, this method of approach gives dealers a chance to emphasize something other than the matter of price.

HOLIDAY TRIMMINGS

Christmas displays are ready and they look like star attractions this year. They have color, action, personalized effects, and they are a great deal more eye-catching and impressive than those trim prepared for small appliances. They are early,

The deluxe 871 with Dual Temp, one of Stewart Warner's 8 new models.



Promotion Head



Such promotion at Norge will now be headed up by M. W. Thompson, who has been named for the post by the firm's v.p. in charge of sales, M. G. O'Harris.

and there are enough of them to make a dealer's holiday window, by themselves.

This year, additional models are being offered along with "extras" such as clocks or kitchen radios, and this gives dealers a good opportunity to accent the "personal gift" angle.

Another stunt which many dealers are counting on, to increase the effectiveness of their displays during the remainder of 1940, is the use of "dinner spreads" connected with Thanksgiving and Christmas dinners. After all, one of the most festive aspects of these holidays is the "food" part, and what is more important in the preparation of delicious food, than a new refrigerator? Many retailers are taking this theme for novel displays.

Two more things which dealers will want to give special attention this year are (1) A vigorous and dramatic publicity and promotion campaign on the brand new features of refrigerators, and (2) A clear and practical announcement of the time-honored facilities which are now available.

RADIO TODAY

Broadcasting's 20th Birthday with Sensational ANNIVERSARY OFFER

on purchase of new 1941

RCA Victrola

with Exclusive Tone Guard!

YOU said: "Give us *another* opportunity like the great RCA Victrola 40th Anniversary Celebration!"

WE say: "Take a look at this new RCA Victrola 20th Anniversary-of-Broadcasting offer!"

Here is the same type of Anniversary Offer that sold thousands of RCA Victrola models for thousands of RCA Victor dealers two years ago! But with this important difference: Today, RCA Victrola values are greater than ever!—public interest in phonograph-radios is more intense than ever—and new 1941 RCA Victrola models offer more features than ever for the finest performance ever offered the American public... *your* customers and ours!

Make this mental note now: "Get details of RCA Victrola giant trade-in offer from your distributor today!" You'll be mighty glad you did!



Trademarks "RCA Victor" and "Victrola" Reg. U.S. Pat. Off. by RCA Manufacturing Company, Inc.

Victrola

A Service of the Radio Corporation of America

3 people out of every 5 will hear
BROADCAST

messages!



—and 1 in every 3
will see this RCA Victrola
ADVERTISING!

Powerful RCA Victrola advertising in national magazines like The Saturday Evening Post, Collier's, The New Yorker, Time and Esquire, will reach one-third of all Americans!





Another Great Step Forward!

PROMISE...PERFORMANCE

and

PROGRESS!

Last year 36... this year only **31**
RCA Preferred Type Tubes!

PROMISE November 1939... Wilderness and confusion in the tube industry—the unregulated evil of “too many tube types.” For the first time, a manufacturer points *a way out*. RCA leadership and experience— and months of study—permit the announcement: “Just 36 Preferred Type Tubes cover virtually every requirement in the design of radio receivers — for finest performance at lowest overall cost!”

PERFORMANCE June 1940... In six short months, the RCA Preferred Type Tubes Program has been endorsed and adapted to production by 18 leading manufacturers of radio receivers. Results—? Better, more uniform tubes. Faster deliveries— from *stock*. Lower inventory and warehousing costs. The entire industry has benefited!

PROGRESS November 1940... One year has passed. Manufacturers have announced still more new tube types—and more, and more. There are now *over 500* types on the market! Does RCA *still* say that you can do a complete job with only 36 types—?

RCA goes farther even than that! From the experience and proof-of-performance of the past year, RCA now makes the still more sensational statement: “Only 31 Preferred Types will cover virtually every requirement for modern radio receivers.” Another great step!

Increasingly, this Program moves *forward*—to the betterment of manufacturer, distributor, dealer, serviceman and public alike.

Over 380,000,000 RCA Radio Tubes have been purchased by radio users.



18 LEADING SET MANUFACTURERS
HAVE ENDORSED AND ADOPTED THIS PROGRAM!

- ★ ADMIRAL ★ ANDREA ★ AUTOMATIC
- ★ DETROLA ★ DE WILD ★ EMERSON
- ★ FADA ★ FARNSWORTH ★ GAROD
- ★ GILFILLAN ★ HALLICRAFTERS ★ PACKARD-BELL
- ★ PILOT ★ RCA VICTOR ★ SENTINEL
- ★ SONORA ★ STROMBERG-CARLSON ★ WURLITZER



CELEBRATING 20 YEARS

Old-Timer Tom White
and Friends

(Continued from page 19)

erator across the room raised his hand, for quiet:

"Got a message for you. It's the U.S.S. Pennsylvania on her way out to sea. Operator says he's got his shaft jammed with officers and men listening in on your music. Has taken headsets apart to pass individual receivers around. His message for you is, Music coming in fine. But for C's sake, change the tune!"

"And so our first fan response. The wireless telephone was indeed a means of entertainment. Music could be transmitted. And people would listen in. Meanwhile, Dr. Lee DeForest was doing similar experimental work in New York City, and we often heard his test numbers and conversations over the air, and occasionally his phonographic music. He, too, was limited at the time by an arc-type oscillator and direct microphone modulation."

RCA Makes Trade-In Offer on Anniversary Model

A salute to the 20th birthday of radio has been announced by RCA Victor, with a feature offer on the 9-tube automatic phonograph-radio model V-205. This instrument will be presented with a liberal trade-in allowance which will reduce the price as much as 20 per cent. V-205 has been regularly listed at \$150.

RCA commercial vice-president Henry C. Bonfig, in commenting on the anniversary celebration, pointed to "many contributions made by the famous RCA Research Labs." and said that "on this birthday of broadcasting those who have learned to appreciate good music through radio are able now to enjoy this service on a deluxe instrument via automatic record reproduction or by radio reception."

"Millions of new buyers" will hear of the RCA celebration offer via ads in all key markets, sales helps, etc.

Emerson Caps 25 Years with New Models

It's the 25th anniversary for the Emerson Radio & Phonograph Corp., who started in business in New York in 1915 as the Emerson Phonograph Co., maker of records and phonographs. The company is celebrating with a coast-to-coast presentation of its new "Patriot" radio model (RADIO TODAY, October, p. 26) and ten other new models for complete 1941 lines. The red-white-and-blue "Patriot" was introduced to dealers at a rousing meeting in New York by Ben Abrams, Emerson president, and similar events are being arranged in other cities by general sales manager Charles Robins.

In his anniversary statements, Mr. Abrams said that the "Patriot" was the 4,000,000th Emerson set off the production lines, and that "for years we have always been the world's largest maker of small radios and today we are the world's largest maker of all home radio." Reasons for the progress were

cited as "constant engineering and style innovations, mass production and low prices, and widespread and continuous use of newspaper advertising."

Magnavox's Many Firsts

It is doubtful that any other company in the radio industry has had such a romantic history as Magnavox—or one so studded with achievements and contributions to the science. Beginning with 1911 when Peter Jensen and E. S. Pridham developed the electro-dynamic loud speaker, Magnavox set the pace in tone reproduction and cabinet design.

Among the other notable developments contributed to the industry by Magnavox are:

1915—Installation of first successful public-address system in Tower of Jewels at San Francisco Exposition.

1918—270 United States war and merchant ships equipped during the World War with Magnavox marine communication equipment.

1919—First electric phonograph introduced by Magnavox.

1922—First amplified radio-phonograph combination built and introduced by Magnavox.

1923—First single-dial-controlled radio produced by Magnavox.

1933—Installation of largest centralized sound distribution system ever developed, throughout the grounds of "A Century of Progress" World's Fair, Chicago.



Jensen vice-president and sales manager, Tom White, left, inspects with Ralph Glover, new Jensen dual-speaker counter display for distributors. Display stands on new CRJ-51 reproducer.

It will surprise many veterans to realize that the amplified radio-phonograph combination was introduced by Magnavox more than 18 years ago. Even then Magnavox combinations were housed in furniture style period design cabinets.



CAP SAYS:—

H. L. M. CAPRON
Merchandising
Editor

You Cannot Do Today's Job with Yesterday's Methods,-- And Be in Business Tomorrow.

The military leaders of Poland, Finland, Norway, Holland, Belgium and France, have learned from bitter experience that times have changed, that "yesterday's methods" are not good enough for today.

And so, too, in radio merchandising.

The tremendous strides of the mail-order, chains, and discount houses present an increasing threat to the independent dealer and the policies of yesterday.

The inflated list price, the long discount, the trade-in allowance for valueless merchandise, and cumbersome high-cost distribution are millstones around the necks of the independent dealers.

Clearer thinking on the part of manufacturer and dealer alike, with policies and methods keyed to the tempo of the times is indicated if radio distribution as we have known it is to be maintained.

The lessons of 20 years of radio merchandising are many—but from present conditions it would seem that little has been learned.

Is our industry too blind to read—or too selfish to heed—"the handwriting on the wall?"



Shortwave as well as regular broadcast ranges are covered on the five push-button Super Sonomatic shown in this 1941 Buick.

RADIO-

AT THE 1941 AUTO SHOW

New features make latest sets easier to sell to millions of motorists

The idea that the "horseless carriage" is here to stay has been completely accepted for quite a few years. In a much shorter time, auto radios have proved themselves an invaluable convenience to modern motoring.

Radio is certainly right in front with new style and convenience features, too. All the sleek new buggies shown for the first time at the National Automobile Show in New York, have super convenient controls for the tuning of programs. Everybody has push-buttons; metal buttons, plastic buttons, piano-key shapes, plunger types, horizontal rows, vertical rows. One manufacturer has a rotary station selector which may also be remotely operated; more about that later. Dial scales are up where you can see them or tilted on a visible angle. All except one car has the controls mounted in the center of the dash panel.

Antennas are of the single rod type, mainly the popular cowl mounted whip-type. Extension of the antenna in some cases is externally manual, others are raised and lowered by a small crank mounted on the side wall just below the dash, some are operated by the manifold vacuum and a dash push button. Several cars have the center windshield mounting antenna with a combination turning and extension handwheel. These aerials are the ones which mount through the roof just above the windshield and swing up above the roof when in use.

VERTICAL DIALS

Here are some details on particular cars. The Chrysler products, Dodge, Plymouth, DeSoto, and Chrysler have a new arrangement of the radio controls. The tuning dial scale and seven push buttons are arranged in a ver-

tical pattern just to the left of the center dash speaker grill. Push buttons are available for 5 stations while the other two in the set are for "off" and "on." A wind-up cowl mount antenna is operated with a small crank.

SLIDE RULE DIALS

Studebaker has four and six station push-button models. The dial scale and buttons are horizontal and mounted in the center of the dash. The push buttons are divided into two groups, one on each side of the manual tuning knob. A tone control is also on the dash as one of the new radio features.

These cars have a wind-up antenna mounted just above the windshield dividing strip.

The majority of the sets have five push-buttons and all have a slide rule dial. The dials have been inclined or mounted on the panel so that they are more visible to the operator.

Hudson radios by Stewart-Warner have molded piano-type keys set along the lower edge of the dash for four stations. The manual tuning and volume control knobs are of the knurled wheel-type. One finger can be used to quickly adjust the radio. A vacuum operated antenna is used.

Two cars are featuring the Zenith foot controlled station selector. These are the Nash and Ford products, Mercury, Lincoln, and Ford. The Ford radios have a rotary station selector which chooses any of five stations or the manual dial by turning a pointer knob just below the dial scale. The station selecting may also be done by the driver with a foot control switch. This switch looks exactly like the conventional light dimmer control. Besides selecting the next station, the switch mutes the program when it is depressed only part way. This gives a feature of safety and convenience since the program can be instantly cut to listen at railroad crossings, etc.

FOOT CONTROL

In operation, the foot switch controls a solenoid having a flat spring leaf connected to the plunger and a coil spring which holds the plunger normally out of the core. The leaf spring has a rectangular slot which engages a pawl gear on the shaft of the rotary station selector switch. As the coil is energized by depressing the foot switch all the way, the plunger is pulled into the core and the leaf

FLEETS OF AUTOS NEED RADIO!

Cars in use.....	26,201,395
Car radios in use.....	7,200,000
Used cars sold last year.....	6,000,000
New cars sold last year (peak in Dec.).....	2,975,165
Auto radios sold last year.....	1,200,000
Car sales since 1936.....	9,168,846
Per cent of all vehicles on farms or in towns under 2,500.....	41
Per cent in cities over 500,000.....	13
States with largest increases in cars last year:	
Mississippi.....	13.4%
Idaho.....	11.2
Arkansas.....	9.5
South Carolina.....	9.3
Georgia.....	8.6
Per cent of driving for business purposes	55
Per cent of driving for social and recreational purposes.....	45

spring turns the selector one step.

The three contact foot switch cuts off the set by grounding out the voice coil when it is depressed part way. When the foot switch is pressed all the way down, the solenoid which turns the station selector switch, is connected to the "A" supply. A "mother-in-law" control can also be installed in the back of sedans to select stations or temporarily cut off the radio.

With new auto radios sporting all the latest conveniences, now is the time to feature these new jobs along with the handy antennas. Check-up on your customers who have new cars and sell them a super 1941 auto radio to go with it.

Blitzkrieg Against Industrial Xmas Sales

A blitzkrieg to stop purchasing agents of industrial firms from buying for employees and to prevent distributors from selling direct to consumers at so-called wholesale prices, is the result of the organization in Cincinnati, Ohio, of a Greater Cincinnati Appliance Dealers Association, made up of radio and electrical dealers, department and furniture stores, representing more than 70 per cent of the retail business done in that territory, with seventy-five dealers enlisted in the organization.

The officers include Harry Shelby, president; Ely Steinberg, vice-president; John Palmer, secretary, and Ferd Hengehold, treasurer.

For some time dealers in Cincinnati, as elsewhere, have faced the serious problem of group purchasing. Cincinnati manufacturers employing many people frequently opened departments for purchasing any type of merchandise that employees needed, and were able to buy this merchandise from distributors who sold to the same dealers.

EMPLOYERS IN RADIO BUSINESS

And while the distributors do not sell the purchasing agents at the same price that they sell the dealers, it is profitable business for these distributors, because they make more money on these sales than when they sell to regular dealers, at the same time that they curtail sales for dealers.

The situation had even reached the point where some very large firms tell their employees "this is a good place to work" because the management is able to save money for employees in buying the necessities as well as luxuries.

WQRX Increased 25-fold

Discriminating listeners around New York City who follow the classical programs of WQXR, New York's high-fidelity station, are happy in the recent increase in the station's power to 5000 watts. The resulting improved reception is expected to en-

large the metropolitan market for the sale of higher-bracket high-fidelity reproduction.

Measurements made of the new transmitter's field strength in the metropolitan area, show a power gain of 25 times, due, according to John V. L. Hogan, president, to "an increase of five, resulting from power alone, and another five times to be credited to the increased efficiency of the new 300-ft. tower and grounding system."

Adams in New Home

R. A. Adams Co., manufacturers' representative of Detroit, Mich., now have new quarters at 18288 Appoline Ave.

Alexander Has 15 Years with Aerovox

While the high points of "20 years of radio progress" are being reviewed this month, one of the sales records of the industry is pointed out by Aerovox Corp., New Bedford, Mass., in the work of one of its sales engineers, Louis Alexander. Mr. Alexander started in radio in 1918 with Dr. Lee DeForest's organization, where he worked two years, and later joined the Dubilier Condenser Corp.

Mr. Alexander started with Aerovox in 1926, and for 15 years has been selling and servicing radio manufacturers and other large users of condensers. His company says "he has sold literally billions of microfarads."

FORD **CHEVROLET** **PLYMOUTH**

Only WARD Flex-Angle FITS ALL 1941 CARS

MERCURY **PACKARD**

ZEPHYR **DODGE**

WILLYS **CHRYSLER**

OLDSMOBILE **DE SOTO**

PONTIAC **HUDSON**

BUICK **NASH**

CADILLAC **LINCOLN**

Scoop!

Radio service men can fit EVERY 1941 CAR with the WARD Flex-Angle* aerial. This one model—with no extra parts—is perfectly adaptable to all new models, including those with little or no side cowl. Four-foot waterproof* lead cable permits mounting on FENDER, where cowl installation is impossible. Be prepared for the new 1941 car business. Stock up with WARD Flex-Angles.

If you do not have a copy, send for the 1940 Ward Catalog and 1941 Antenna Guide

*Exclusive with WARD

The WARD PRODUCTS CORP.
WARD BUILDING CLEVELAND, OHIO

Patent Pending

PARTS STOCK DRESS-UP

JOBBERS STRESS FINGER-TIP SERVICE FROM STREAMLINED BINS



Above are shelves to the ceiling, and new style island display at Radio Specialties Co. (Los Angeles) new branch at Phoenix, Ariz. Tube stock is Tung-Sol. Other sections feature Recordio.

At left, a trio of glistening floor fixtures show strings of test instruments and small radios, at Radio Supply Co., Co., Norfolk, Va.



Note the novel counter and the rows of extra bins for parts, in the well-lighted lay-out at the Brower Electric Supply Co., Greensboro, N.C.

Road to Progress



Here—in chronological order—are a few of the many thousands of RCA contributions to radio—important contributions which have given America the most efficient radio service in the world!

- 1919** Radio Corporation of America organized—to insure ownership in the United States of the country's international radio communication facilities.
Marconi Wireless Telegraph Company of America assets and business acquired by RCA.
- 1920** Commercial radio telegraph service between the U. S. and foreign countries begun.
- 1921** Vacuum tubes for operation from storage batteries and dry cells, the first to bear the RCA trademark, were developed and manufactured.
International radio telegraph transmitting station was established at Rocky Point, L. I., New York, and receiving station at Riverhead, L. I.
- 1923** WJZ, WJY opened in New York; WRC in Washington. Frequency control of transmitters by means of quartz crystals employed.
- 1924** Pioneer experimental trans-Atlantic transmissions of radio photographs conducted.
Superheterodyne receiving sets introduced for broadcast reception.
Broadcasting first used in national political campaign. Conventions of both major parties broadcast.
- 1925** First international broadcasting program received from England and re-broadcast through WJZ.
Radio broadcast receiving sets with battery eliminators offered, affording complete "light socket" operation. Dynamic loudspeaker introduced.
Apparatus introduced for recording and reproducing phonograph records electrically.
- 1926** National Broadcasting Company organized to provide national program service, available to broadcasting stations throughout the country. First NBC program broadcast November 15, 1926.
Commercial facsimile (radiophoto) service begun between New York and London.
- 1927** Second NBC network organized with WJZ as key station in New York.
First alternating current receivers utilizing tubes operated from light socket announced.
Sound-on-film talking motion pictures introduced. Radiomarine Corporation of America organized to operate in marine communication field.
- 1928** Experimental television transmitters with mechanical scanning, tested in New York.
- 1929** R.C.A. Communications, Inc., organized to carry on RCA's international communication services.
Screen-grid tubes made available.
All-electronic television receiver using a Kinescope cathode-ray tube demonstrated.
- 1930** All RCA facilities for research, engineering, manufacturing and sales operations were consolidated.
- 1931** Television field tests begun, continuing through 1932, employing a mechanical scanner at transmitter, and cathode-ray reproduction in receiver. Ultra-high frequency radio telephone links Hawaiian Islands in an inter-island telephone service. Noiseless motion picture recording, and a low-cost sound picture reproducer for direct AC operation, were introduced.
- 1932** Ribbon-type high fidelity microphone, for broadcasting and sound recording announced.
- 1933** "Acorn tube" developed for ultra-high frequencies. Field tests made of first "all-electronic" television, with Iconoscope "electric eye" for scanning.
- 1934** Multiple-band receivers introduced for direct home reception of international shortwave programs.
R.C.A. Communications, Inc., established its inter-city radio telegraph service in the United States.
- 1935** Automatic "SOS" alarm developed for use on vessels not having an operator constantly on watch. All-metal tubes announced.
"Electron image tube" demonstrated for use in biological and physical microscopic research.
- 1936** First high-definition, all-electronic television field tests conducted in New York.
New method of ultra-violet light recording for sound motion pictures introduced.
- 1937** NBC Symphony Orchestra, the first full-size symphony orchestra devoted exclusively to radio, was organized. First performance broadcast Nov. 2, under the direction of Maestro Arturo Toscanini.
- 1938** Field tests made of radio broadcast facsimile system.
- 1939** First regular public television program service inaugurated in the United States by televising the opening ceremonies of the New York World's Fair. Improved system of transmitting "Radiophotos" between the United States and England introduced. RCA opened comprehensive exhibits at New York and San Francisco World's Fairs.
- 1940** Electron Microscope announced, affording magnification up to 30,000 diameters, and opening new worlds for industrial and medical research. Portable radio facsimile recorder developed.
- The radio industry places national defense as the Number One Order for all departments, with an "all out" program to provide America's naval and military organizations with the most advanced radio equipment in the world.
- First telecast of Presidential candidates, and first telecast of election returns, made in New York.

"THIS IS THE NATIONAL
BROADCASTING COMPANY"



"THIS is the National Broadcasting Company!" Those words were meaningless twenty years ago. Today, they are familiar to every American.

For they identify the first and greatest broadcasting company, organized by RCA in 1926, whose services today have become an important part of the American way of living.

Through its two coast-to-coast networks—the "Red" and the "Blue"—

we enjoy the music we like best—symphony or swing, opera or jazz. We laugh with world-famous comedians—or thrill to stirring drama broadcast by stars of radio, stage and screen. We hear vital news of the day almost as it happens—and we hear important issues discussed from both sides, so that we may form our opinions.

Through its special shortwave broadcasts, NBC has helped to create a bond

of friendship between the United States and our sister republics of the Western Hemisphere, increasing the unity of purpose and sympathetic understanding between the Americas. That these services of NBC are so outstanding is due in part to the fact that NBC draws freely upon the experience, research and resources of its parent company—RCA, the only organization that makes and does *everything* in radio and sound.



Radio Corporation of America

RCA Manufacturing Company, Inc.

Radiomarine Corporation of America

National Broadcasting Company

R. C. A. Communications, Inc.

RCA Laboratories

RCA Institutes, Inc.



WE'RE VERY CAREFUL ABOUT OUR $H_2KAl_3(SiO_4)_3$



$H_2KAl_3(SiO_4)_3$ (mica to you) is used extensively in insulating against heat and electricity. In Sylvania Radio Tubes it also prevents vibration of wires and elements. Mica makes a good insulator and support when treated right and used right . . . and that's why Sylvania splits and fabricates its own.

By doing so, Sylvania is assured of close control over this important tube part. Each tough cleavage flake must have the proper flexibility and elasticity. Each must be only the 8 to 15 thousandth inch leaf that makes a good support and insulator. We know the ones in Sylvania Tubes are right—because we make them that way.

Our careful handling of mica is but one of the many special operations which guard the quality of Sylvania Radio Tubes and insure satisfied customers for you. Hygrade Sylvania Corporation, Emporium, Pa.

*Also Makers of Hygrade
Lamp Bulbs and Miralume
Fluorescent Light Fixtures*

SYLVANIA

SET-TESTED RADIO TUBES

PHILCO World

Auto Radio Manufacturer . . .

NEW AUTO RADIO FOR 1941



AR-10. Attractive, rugged one-piece case finished in beautiful Crystal Green. Fits snugly under the instrument panel of any car. 6-tube Superheterodyne with Built-in Speaker and Illuminated, Easy-to-read Dial. The finest low-priced auto radio ever offered . . . **\$19⁹⁵**



AR-40. Single-unit Superheterodyne in a smart new case finished in Tan. 6 tubes, powerful Built-in 6-inch Speaker. Separate Control Unit with 2-point Tone Control, Illuminated Dial and Plate to match any car. Fine all-around performance. A big value. **\$29⁹⁵**



AR-45. Two-unit Superheterodyne in a smart new case finished in Tan. Choice of separate 7-inch Dash Speaker. Separate Control Unit with 2-point Tone Control and Illuminated Dial and Plate to match any car. **\$39⁹⁵**



AR-50. Single-unit Superheterodyne in the new Crystal Green Case with Chrome Trim. 6 tubes, powerful Built-in 6-inch Speaker. Separate Illuminated Control Unit with new tuning convenience — left knob controls volume and tone, right knob tunes all stations or acts as push-button for 5 favorite stations. Plate to match any car. Only . . . **\$39⁹⁵**

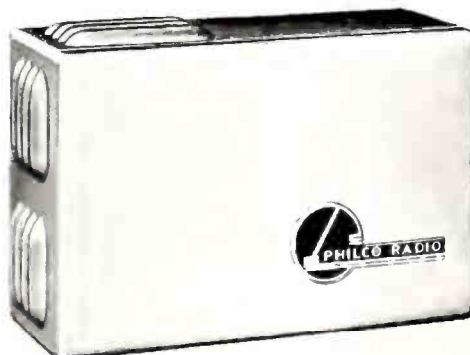

AR-55. Two-unit Superheterodyne in Crystal Green Case with Yellow Ornament. 6 tubes. Choice of separate 7-inch Grille Speaker or Under-Dash Speaker. Separate Illuminated Control Unit — left knob controls volume and tone, right knob tunes all stations or acts as push-button for 5 favorite stations. Plate to match any car. Superb tone and performance. **\$44⁹⁵**



AR-75. De Luxe two-unit Superheterodyne in Crystal Green Case with Yellow Ornament. 8 tubes. Separate 7-inch Grille Speaker and 7-inch Under-Dash Speaker. Both set and speaker finished in Crystal Green with Chrome Pull Beam Output. Separate Illuminated Control Unit with Single Push-button for 5 favorite stations, 3-point Tone Control and Illuminated Dial and Plate to match any car. **\$54⁹⁵**

**Largest
announces
105**

THROUGH all the years that Philco has maintained overwhelming leadership in home radio, Philco has also been the world's largest manufacturer of *automobile radios*. Today, the great majority of radios operating in the cars of America have been manufactured by Philco.

Through all these years, Philco has *pioneered* the development of automobile radio. From its very beginning, Philco research and engineering, through intimate contact with the leading engineering brains of the automobile industry, have brought the auto radio to its present state of perfection.

Not only Philco Auto Radios but *all* auto radios are better today because of the original ideas that Philco research has created, the difficult problems which Philco engineering has solved.

And now, Philco announces, for sale through the radio and automotive outlets of the country, the greatest line of auto radios it has ever produced... the simplest, most flexible and most profitable proposition ever offered to the auto radio dealers of America.

**Control Plates to Match
the Panels of ALL Cars
...AT NO EXTRA COST!**

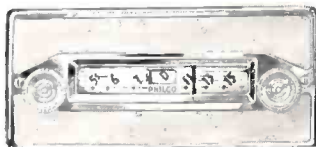

Philco offers you for 1941 an extremely simple and flexible control plate proposition. The controls for all models are exactly the same size and shape. You have a choice of 64 mounting plates that fit into the instrument panels of practically every car from 1938 to 1941... or, the Philco Universal Under-Dash Mounting which

fits under the instrument panel of *any* car.

Your choice of any plate to fit any car is included in the list price of every Philco Auto Radio... *no extra charge for matched installation!* And, in addition, the installation itself has been tremendously simplified. Easier to stock; easier to sell; easier to install!

**Speakers to Mount
in Grilles of All Cars**

The Philco Auto Radio models with separate speakers are also supplied to permit a "factory fit" in any car. For cars equipped with a speaker grille, a speaker is supplied that fits back of the grille. Or, if desired, a speaker in a separate housing to be mounted under the dash.

In price, style, tone, performance and ease of installation, Philco offers you for 1941 the greatest values in the auto radio market and bigger opportunities for profit than ever before. Get the full story from your Philco distributor now.

**New! Exclusive!
Short-Wave Tuner**

A brand-new accessory, invented by Philco engineers, that makes a short-wave radio out of any 1941 Philco Auto Radio (except AR-10)! Adds two tubes and four short-wave tuning bands to the set and enables users to enjoy powerful American and Foreign Short-Wave reception. Tunes in programs by short-wave in spots too far or too noisy for good reception on standard bands. A sensational PLUS for Philco dealers. **\$20**
Only Philco has it! Only...

PHILCO ALL YEAR 'ROUND

HOME RADIO • PHONOGRAPHS • TELEVISION • AUTO RADIO
RADIO TUBES • PARTS • REFRIGERATORS
AIR CONDITIONERS • DRY BATTERIES

a beautifully
ment. 6 tubes.
er or Under-

\$34⁹⁵

erodyne with
ash Speaker.
shing Luding-
Stage Push-
ated Control

\$59⁹⁵

PHILCO

World's Largest
Auto Radio Manufacturer ... Announces
**NEW AUTO RADIOS
FOR 1941**



AR-10. Attractive, rugged one-piece case finished in beautiful Crystal Green. Fits snugly under the instrument panel of any car. 6-tube Superheterodyne with Built-in Speaker and Illuminated, Easy-to-read Dial. The finest low-priced auto radio ever offered. **\$19⁹⁵**



AR-40. Single-unit Superheterodyne in a smart new case finished in Tan. 6 tubes, powerful Built-in 6-inch Speaker. Separate Control Unit with 2-point Tone Control, Illuminated Dial and Plate to match any car. Fine all-around performance. A big value. **\$29⁹⁵**



AR-45. Two-unit Superheterodyne in a beautifully finished Tan Case with Yellow Ornament. 6 tubes. Choice of separate 7-inch Grille Speaker or Under-Dash Speaker. Separate Control Unit with 2-point Tone Control, Illuminated Dial and Plate to match any car. **\$34⁹⁵**



AR-50. Single-unit Superheterodyne in the new Crystal Green Case with Chrome Trim. 6 tubes, powerful Built-in 6-inch Speaker. Separate Illuminated Control Unit with new tuning convenience—left knob controls volume and tone, right knob tunes all stations at once as push-button for 5 favorite stations. Plate to match any car. Only **\$39⁹⁵**

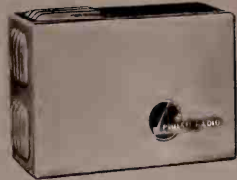

AR-55. Two-unit Superheterodyne in Crystal Green Case with Yellow Ornament. 6 tubes. Choice of separate 7-inch Grille Speaker or Under-Dash Speaker. Separate Illuminated Control Unit—left knob controls volume and tone, right knob tunes all stations at once as push-button for 5 favorite stations. Plate to match any car. Superb tone and performance. **\$44⁹⁵**



AR-75. De Luxe two-unit Superheterodyne with 8 tubes. Separate 8-inch Under-Dash Speaker. Both set and speaker finished in refreshing Ludington Green with Chrome Trim. R. E. Stage Push-Pull Beam Output. Separate Illuminated Control Unit with Single Push-Button for 5 stations, 3-point Tone Control and **\$59⁹⁵** Plate to match any car.

**Control Plates to Match
the Panels of ALL Cars
... AT NO EXTRA COST!**



Philco offers you for 1941 an extremely simple and flexible control plate proposition. The controls for all models are exactly the same size and shape. You have a choice of 64 mounting plates that fit into the instrument panels of practically every car from 1938 to 1941... or, the Philco Universal Under-Dash Mounting which

fits under the instrument panel of any car. Your choice of any plate to fit any car is included in the list price of every Philco Auto Radio... no extra charge for matched installation! And, in addition, the installation itself has been tremendously simplified. Easier to stock; easier to sell; easier to install!

**Speakers to Mount
in Grilles of All Cars**

The Philco Auto Radio models with separate speakers are also supplied to permit a "factory fit" in any car. For cars equipped with a speaker grille, a speaker is supplied that fits back of the grille. Or, if desired, a speaker in a separate housing to be mounted under the dash.

**New! Exclusive!
Short-Wave Tuner**

A brand-new accessory, invented by Philco engineers, that makes a short-wave radio out of any 1941 Philco Auto Radio (except AR-10). Adds two tubes and four short-wave tuning bands to the set and enables users to enjoy powerful American and Foreign Short-Wave reception. Tunes in programs by short-wave in spots too far or too noisy for good reception on standard bands. A sensation at PLUS for Philco dealers. **\$20** Only Philco has it! Only

In price, style, tone, performance and ease of installation, Philco offers you for 1941 the greatest values in the auto radio market and bigger opportunities for profit than ever before. Get the full story from your Philco distributor now.

PHILCO ALL YEAR 'ROUND

HOME RADIO • PHONOGRAPHS • TELEVISION • AUTO RADIO
RADIO TUBES PARTS REFRIGERATORS
AIR CONDITIONERS • DRY BATTERIES

YOU can make MORE PROFITS By Selling Wilcox-Gay Prospects



It's Revolutionary!
RECORDER — RADIO — PHONOGRAPH
Portable Model!
RECORDIO JUNIOR
(Microphone Included)

PRICE
\$ 39⁹⁵—
F. O. B.
CHARLOTTE
MICH.

When Customers Say: "I Want a Christmas Gift That's Different!"—
Show Them **RECORDIO JUNIOR**

- Attractive, Sturdy, Airplane-Style Luggage Covering.
- Easy to Carry—Weighs Less Than Twenty Pounds!
- Easy to Demonstrate Convincingly—Built-In Loop Antenna.
- Convenient Size: 12¹/₄" x 12¹/₂" x 9³/₈"; Snap-On Cover, Strong Handle.
- Plays 10" and 12" Records.

RECORDIO JUNIOR

"A Recorder for the MILLIONS"
FOR PROMPT DELIVERY, ORDER TODAY

Wire or write your nearest distributor listed

ALBANY, N. Y.
Albany Garage Company
ATLANTA, GA.
Specialty Distributing Co.
AUBURN, ME.
Darling Automobile Company
BALTIMORE, MD.
Lincoln Sales Corporation
BAY CITY, MICH.
Kinde Distributing Company
BINGHAMTON, N. Y.
Whele Electric Company
BIRMINGHAM, ALA.
E. E. Forbes & Sons
BLUEFIELD, W. VA.
Bluefield Hardware Company
BOISE, IDAHO
W. H. Bintz Company
BOSTON, MASS.
Mithender-Ales Electrical Co.
BUFFALO, N. Y.
Whele Electric Company
BURLINGTON, IOWA
Union Supply Company
CHARLESTON, W. VA.
West Virginia Htg. & Plumb. Co.
CHICAGO, ILL.
Wakem & Whipple, Inc.
CINCINNATI, OHIO
York Supply Company
CLARKSBURG, W. VA.
Professional Radio Supply
CLEVELAND, OHIO
Goldhamer, Inc.
COLUMBUS, OHIO
McCleery-Carpenter Electric Co.
DALLAS, TEXAS
W. E. Titus Wholesale Company
DAYTON, OHIO
Standard Radio Parts Co.
DENVER, COLO.
Inter-State Radio & Supply Co.

DES MOINES, IOWA
Iowa Radio Corporation
DETROIT, MICH.
Chas. W. Held Company
DUBUQUE, IOWA
Renler Radio & Television Co.
ERIE, PA.
Warren Radio Company
FORT WAYNE, IND.
National Mill Supply Company
FORT WORTH, TEXAS
The Mart, Inc.
GRAND RAPIDS, MICH.
Nilsson Distributing Company
HAGERSTOWN, MD.
Tristate Electrical Supply Co.
HARLAN, KY.
Cumberland Valley Music Co.
HARTFORD, CONN.
Hatry & Young, Inc.
HARRISBURG, PA.
Radio Distributing Company
HAZLETON, PA.
Robert A. Sylvester
HOUSTON, TEXAS
Readers Wholesale Distributor
INDIANAPOLIS, IND.
Radio Distributing Co.
JACKSONVILLE, FLA.
Glover Weiss Company
KANSAS CITY, MISSOURI
Jenkins Music Company
KNOXVILLE, TENN.
Sterchl Brothers Stores, Inc.
LEXINGTON, KY.
Barney Miller
LITTLE ROCK, ARK.
Fones Bros. Hardware Co.
LOS ANGELES, CAL.
Radio Specialties Company

WILCOX-GAY CORPORATION

WILCOX-GAY—MANUFACTURERS OF THE FAMOUS RECORDIO

Radio's Greatest NEW Market in 20 Years!

RCA VICTOR Personal Radio

FOR AMERICA-ON-THE-MOVE!

Out of 20 years of RCA and RCA Victor progress in radio, a great NEW radio market is opened! Widely publicized . . . written about . . . talked about . . . the RCA Victor PERSONAL Radio has become the sensation of the Nation — overnight!

Weighing only 4¼ pounds — measuring only 3½" x 8½" x 3" — this supersensitive superheterodyne puts to shame the performance of many a much larger portable! No wonder the first dealers to carry the Personal Radio sold out their entire stock — not in just a few days . . . but in a few hours! And the demand still far exceeds the supply!

With Christmas just around the corner — can you imagine a greater immediate-profit opportunity? And with the entire country a vast unsaturated market for this brand-new idea in radio . . . can you imagine a greater lasting opportunity?



Trademark "RCA Victor" Reg. U.S. Pat. Off. by RCA Mfg. Co., Inc.



—And Don't Forget the Great "Little Nipper" Line!



MODEL 10X

A BIG radio, engineered to compact size! Amazing new Roto-Base! Built-in Magic Loop Antenna! 5 Tubes!

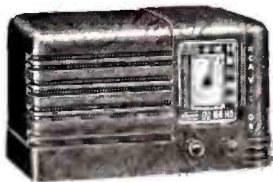

MODEL 45X-1

7-Tube performance from 5 RCA Victor Preferred Type Tubes! "Hank" antenna attached, no ground required! Beautiful Mahogany Plastic Cabinet! Superheterodyne!

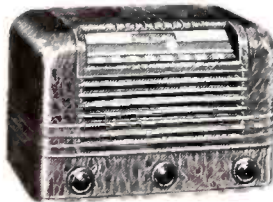

MODEL 15X

The great RCA Victor "Super Six" — A super-value, supersensitive superheterodyne with 6 tubes . . . Plastic Cabinet! Magic Loop! Roto-Base!

Gifts for Soldiers!
Profits for You!

... The draft is on! Thousands of Americans will be leaving home for training camps all over the country. And thousands of Little Nippers will be sold to keep them company!



RCA Victor Celebrate



Easy to Demonstrate—Easy to Sell

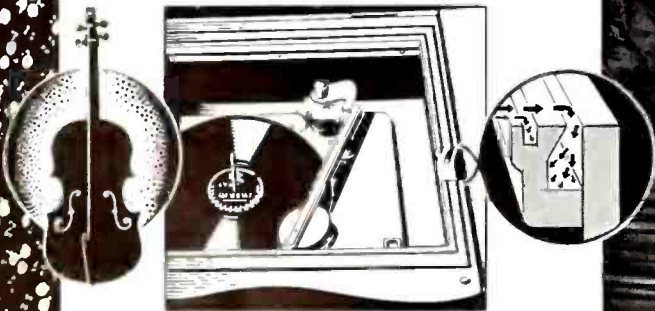

New RCA Victrola TONE GUARD!

The RCA Victrola Tone Guard looks amazingly simple. But sales-minded dealers have pointed out to customers that built into the instrument's cabinet-wall around the record chamber is an ingenious invention. Scientifically shaped slots, much like the "f-slots" that have been used on violins for centuries, play an important part in the reproduction of rich, pure tone. These slots capture—and suppress—the *unwanted* mechanical noises present in all phonograph-radios. An easy way to demonstrate the effectiveness of the Tone Guard is to play a record with the lid of the instrument open. While the record is being played, close the lid—immediately mechanical noises are sealed in silence.



RCA VICTROLA V-205—Feature-packed to sell! Exclusive RCA Victrola Tone Guard. Gentle-Action, Automatic Record Changer with *top-loading* Crystal Pickup. 9 RCA Victor Preferred Type Tubes. Two Built-in Antennas for American and Foreign Reception. 6-station Stabilized Electric Tuning. Television or F-M plug-in. All in an exquisite, beautifully-finished cabinet that only 42 years of RCA Victrola background-in-craftsmanship could produce!



RCA

Combines Radio and Record Entertainment

A Preview of Christmas



Our inside information department reports that all signs point toward an enormous DECCA business this Christmas Season. After the greatest summer volume in the history of DECCA, our three big factories are building up toward maximum production, and, try as we may, it appears that it's going to be difficult to give perfect service this holiday season unless you help us by — **ANTICIPATING YOUR STOCK NEEDS FOR DECCA RECORDS FOR CHRISTMAS NOW!!**
Complete lists of all Christmas merchandise are available at branches and we urge you to secure your lists and place your orders as quickly as possible.

DECCA Records



SUPERIOR • AUTOMATIC • ACOUSTIC • TRANSCRIPTION . . . STEEL and STELLITE CUTTING . . . SAPPHIRES

RECOTON

Needles



INSURE BETTER RECORD PERFORMANCE...

Send for Literature

RECOTON CORPORATION

178 Prince St. New York, N. Y.

RCA Victor Celebrates



Easy to Demonstrate — Easy to Sell



New RCA Victrola TONE GUARD

The RCA Victrola Tone Guard looks amazingly simple. But sales-minded dealers have pointed out to customers that built into the instrument's cabinet-wall around the record chamber is an ingenious invention. Scientifically shaped slots, much like the "f-slits" that have been used on violins for centuries, play an important part in the reproduction of rich, pure tone. These slots capture—and suppress—the unwanted mechanical noises present in all phonograph records. An easy way to demonstrate the effectiveness of the Tone Guard is to play a record with the lid of the instrument open. While the record is being played, close the lid—immediately mechanical noises are sealed in silence.



RCA VICTROLA V-205 — Feature-packed to sell! Exclusive RCA Victrola Tone Guard. Gentle-Action, Automatic Record Changer with top-loading Crystal Pickup 9 RCA Victor Preferred Type Tubes. Two Built-in Antennas for American and Foreign Reception. 6-station Stabilized Electric Tuning. Television or F.M. plug-in. All in an exquisite, beautifully-finished cabinet that only 42 years of RCA Victrola background-in-craftsmanship could produce!



RCA

Combines Radio and Record Entertainment

A Preview of Christmas



Our inside information department reports that all signs point toward an enormous DECCA business this Christmas Season. After the greatest summer volume in the history of DECCA, our three big factories are building up toward maximum production, and, try as we may, it appears that it's going to be difficult to give perfect service this holiday season unless you help us by—**ANTICIPATING YOUR STOCK NEEDS FOR DECCA RECORDS FOR CHRISTMAS NOW!!**

Complete lists of all Christmas merchandise are available at branches and we urge you to secure your lists and place your orders as quickly as possible.

DECCA Records



SUPERIOR • AUTOMATIC • ACOUSTIC • TRANSCRIPTION • STEEL and STEELITE CUTTING • SAPPHIRES

RECOTON

UNIFORM

Needles

INSURE BETTER RECORD PERFORMANCE...

Send for Literature

RECOTON CORPORATION

178 Prince St. New York, N. Y.

YOURS—FO

A parade of new rad



Westinghouse Carryette

The new personal WR682 shown with Rochelle Hudson is a 4 3/4-pound camera-type set finished in black leather and trimmed in chrome.



GE Musaphonic table set

★ Chippendale chest, model 20, in mahogany, walnut or champagne finishes, has 6 tubes, 5 in. Dynapower speaker, 2 built-in antennas. Control panel concealed by doors. Standard, 540-1,600 kc., shortwave, 5,800 to 18,000 kc. \$50 up, according to finish. General Elec. Co., Bridgeport, Conn.—RADIO TODAY.



RCA Radiola

★ All-purpose portable receiver, model P-5 has 5 tubes. Operates on self-contained batteries, or 110 v. AC-DC power. Washable simulated leather cabinet. Magnetite core IF transformers. RCA Mfg. Co., Camden, N. J.—RADIO TODAY.



Motorola farm radio

★ Convertible for AC power line operation, model 52BK uses 1 1/2 v. battery pack inside the cabinet. Has 5 tubes, superhet, 8 in. P.M. dynamic speaker, 2 bands, standard, police and foreign shortwave. Battery saver circuit. Walnut veneer console cabinet. Galvin Mfg. Corp., 4545 Augusta Blvd., Chicago, Ill.—RADIO TODAY.

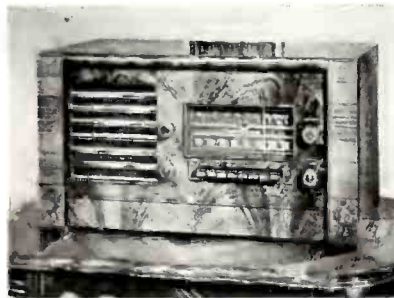

S-C 520J

★ Table radio with walnut cabinet in modern design. Built-in loop, short wave aerial, push-button tuning. Bi-focal tuning eye and tele-FM conuection. Standard and shortwave broadcasts. \$72.50. Stromberg-Carlson Tel. Mfg. Co., 100 Carlson Rd., Rochester, N. Y.—RADIO TODAY.

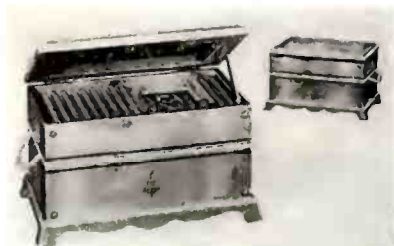

Emerson 405

★ Chest type cabinet of knotty pine with rope carrying handles, in early American style. Contains a

5-tube, AC-DC superhet with tuning range of 187 to 555 meters (540 to 1,600 kc.). Electro dynamic speaker, enclosed super loop antenna. Lid designed for sound deflection. \$19.95. Emerson Radio & Phono. Corp., 111 Eighth Ave., N. Y. C.—RADIO TODAY.



Phonola port. phonograph

★ Model 121-K, amplified portable phono with removable record-carrying drawer holding 14 ten-in. records. Crystal pickup, 9 in. turntable, 6 1/2 in. P.M. speaker, 4 w. output. Plays 10 and 12 in. records with lid closed. Water-proof, gray-green simulated leather case. \$24.95. Waters-Conley Co., Rochester, Minn.—RADIO TODAY.

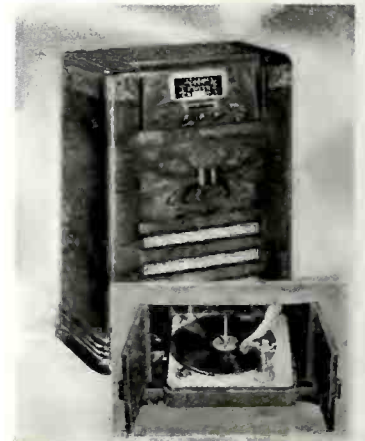

Admiral combo.

★ Seven-tube, AC radio and automatic record changer combination. Slide-A-Way changer eliminates bother of removing ornaments from top. Plays 10 and 12 in. records. Standard broadcast and foreign short wave bands. Directional Aeroscope 10 in. P.M. dynamic speaker. Walnut cabinet. \$99.95. Continental Radio & Telev. Corp., 3800 Cortland St., Chicago, Ill.—RADIO TODAY.

XMAS PROFIT

Ready to join the holiday rush

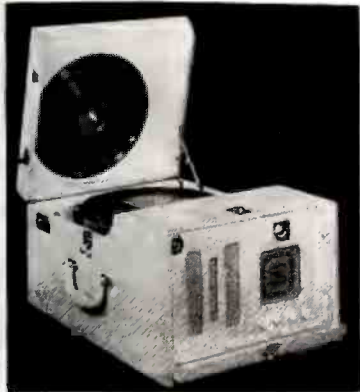

Port-o-Matic Ambassador

★ Portable combination, series 312 with 8-tube superhet radio, standard broadcast and shortwave. Drop type record changer plays and changes twelve 10 in. or ten 12 in. records. Crystal pickup, universal elec. motor. Model 312-F, tan fabricoid, \$139.50; 312-SC, suntan cowhide, \$159.50; 312-R, rawhide, \$179.50. Port-o-Matic Corp., 50 E. 77th St., N. Y. C.—RADIO TODAY.



S-W portable

★ Model 5Y1, superhet portable with 5 tubes and built-in loop antenna. Covers 530-1,600 kc. Operates with batteries or on AC/DC. Pyroxylin coated imitation alligator Fabrikoid, waterproofed case, genuine leather handle. Sliding front panel, lock and key. Electrical line cord in compartment on left side of the cabinet. \$29.95. Stewart-Warner Corp., 1826 Diversey Pkwy., Chicago, Ill.—RADIO TODAY.



Columbia phono

A portable phono with all-directional demountable speaker and hook for hanging, is available at \$35. from Columbia Recording Corp., Bridgeport, Conn. Plays 10 & 12 in. records.



Philco auto radios

★ Model AR-50, a 6 Loktal tube, superhet, single unit set features bass compensation, a.v.c., full-wave vibrator, built-in interference filtering. Manual or push-button tuning control. Crystal green hammertone finish, all-chromium grille, \$39.95. One of new line of 7 models which includes a three band short wave set, AR-65. Philco Radio & Telev. Corp., Tioga & C Sts., Phila., Pa.—RADIO TODAY.

Wilcox-Gay radio-recorder

★ \$39.95 is price of newest portable radio phono recorder, Recordio Jr. New unit weighs less than 20 lbs. Built-in loop antenna; airplane luggage covering. Plays 10 and 12-inch records. Mike included. (This information arrived as RT went to press, too late to make engraving.) Wilcox-Gay Corp., Charlotte, Mich.—RADIO TODAY.

GE table combo

For good home entertainment GE's new table-type home recording radio-phono, below J-629, is ideal. Plays 12-in. records with lid closed. Crystal mike, rim drive turntable. Cuts up to and including 10-in. size records.



DeWald Companionette

★ A 4-tube superhet, weighing 4 lbs., is DeWald's miniature personal radio, 410. Inside the simulated cowhide case is dynamic speaker, Looptenna and long lasting batteries. 1,700 to 540 kc. DeWald Radio Mfg. Corp., 436 Lafayette St., N. Y. C.—RADIO TODAY.



YOURS—FOR XMAS PROFIT

A parade of new radios

ready to join the holiday rush



Westinghouse Corryette

The new personal WR682 shown with Rochelle Hudson is a 4 1/2-pound camera-type set finished in black leather and trimmed in chrome.



Motorola form radio

* Convertible for AC power line operation, model 52BK uses 1 1/2 v. battery pack inside the cabinet. Has 6 tubes, superhet, 8 in. P.M. dynamic speaker, 2 bands, standard, police and foreign shortwave. Battery saver circuit. Walnut veneer console cabinet. Galvin Mfg. Corp., 4545 Augusta Blvd., Chicago, Ill.—RADIO TODAY.

5-tube, AC-DC superhet with tuning range of 187 to 555 meters (640 to 1,600 kc.). Electro dynamic speaker, enclosed super loop antenna. Lid designed for sound deflection. \$19.95. Emerson Radio & Photo Corp., 111 Eighth Ave., N. Y. C.—RADIO TODAY.



Phonofort phonograph

* Model 121-K, amplified portable phono with removable record-carrying drawer holding 14 ten-in. records. Crystal pickup, 9 in. turntable, 6 1/2 in. P.M. speaker, 4 w. output. Plays 10 and 12 in. records with lid closed. Water-proof, gray-green simulated leather case. \$24.95. Waters-Conley Co., Rochester, Minn.—RADIO TODAY.



S-C 520J

* Table radio with walnut cabinet in modern design. Built-in loop, short wave aerial, push-button tuning. Bi-focal tuning eye and tele-PM connection. Standard and shortwave broadcasts. \$72.50. Stromberg-Carlson Tel. Mfg. Co., 100 Carlson Bld., Rochester, N. Y.—RADIO TODAY.

GE Musophonic table set

* Chippendale chest, model 29, in mahogany, walnut or champagne finishes, has 6 tubes, 5 in. Dyna power speaker, 2 built-in antennas. Control panel concealed by doors. Standard, 640-1,600 kc. shortwave, 6,800 to 18,000 kc. 560 up, according to finish. General Elec. Co., Bridgeport, Conn.—RADIO TODAY.



RCA Radiolo

* All-purpose portable receiver, model F-5 has 6 tubes. Operates on self-contained batteries, or 110 v. AC-DC power. Washable simulated leather cabinet. Magnetic core IF transformers. RCA Mfg. Co., Camden, N. J.—RADIO TODAY.



Emerson 405

* Chest type cabinet of knotty pine with rope carrying handles, in early American style. Contains a

Admirol combo.

* Seven-tube, AC radio and automatic record changer combination. Slide-A-Way changer eliminates bother of removing ornaments from top. Plays 10 and 12 in. records. Standard broadcast and foreign short wave bands. Directional Aereoscope 10 in. P.M. dynamic speaker. Walnut cabinet. \$99.95. Continental Radio & Telev. Corp., 3200 Cowland St., Chicago, Ill.—RADIO TODAY.



Port-o-Matic Ambassador

* Portable combination, series 312 with 8-tube superhet radio, standard broadcast and shortwave. Drop type record changer plays and changes twelve 10 in. or ten 12 in. records. Crystal pickup, universal elec. motor. Model 312-F, tan fabricoid, \$139.50; 312-SC, suntan cowhide, \$159.50; 312-R, rawhide, \$179.50. Port-o-Matic Corp., 50 E. 77th St., N. Y. C.—RADIO TODAY.

Wilcox-Gay radio-recorder

* \$39.95 is price of newest portable radio phono recorder, Recordio Jr. New unit weighs less than 20 lbs. Built-in loop antenna; airplane luggage covering. Plays 10 and 12-in. records. Mike included. (This information arrived as RT went to press. Too late to make engraving.) Wilcox-Gay Corp., Charlotte, Mich.—RADIO TODAY.



DeWald Comphonette

* A 4-tube superhet, weighing 4 lbs., is DeWald's miniature personal radio, 410. Inside the simulated cowhide case is dynamic speaker, Loopenna and long lasting batteries. 1,700 to 540 kc. DeWald Radio Mfg. Corp., 436 Lafayette St., N. Y. C.—RADIO TODAY.



S-W portable

* Model 5YL superhet portable with 5 tubes and built-in loop antenna. Covers 630-1,600 kc. Operates with batteries or on AC/DC. Pyroxylin coated imitation alligator Fabrikoid, waterproofed case, genuine leather binding. Sliding front panel, lock and key. Electrical line cord in compartment on left side of the cabinet. \$29.95. Stewart-Warner Corp., 1255 Diversey Pkwy., Chicago, Ill.—RADIO TODAY.



Columbia photo

A portable phono with all-directional demountable speaker and hook for hanging, is available at \$35. from Columbia Recording Corp., Bridgeport, Conn. Plays 10 & 12 in. records.



Philco auto radios

* Model AR-50, a 6 Loktal tube superhet, single unit set features bass compensation, a.c. full-wave vibrator, built-in interference filtering. Manual or push-button tuning control. Crystal green hammer-tone finish, aluminum grille, \$39.95. One of new line of 7 models which includes a three band short wave set, AR-65. Philco Radio & Telev. Corp., Ticon & C. Sts., Phila., Pa.—RADIO TODAY.

GE table combo

For good home entertainment GE's new table-type home recording radio-phono, below J-629, is ideal. Plays 12-in. records with lid closed. Crystal mike, rim drive turntable. Cuts up to and including 10-in. size records.



NEW PRODUCTS



Freed-Eisemann receiver

★ New 20 tube, FM-AM automatic radio phono combination. Short, medium and BC wave bands. Electron tuning indicator, dual speakers. Walnut or mahogany Chippendale. AC. DC also available. Freed Radio Corp., 39 W. 19th St., New York, N. Y.—RADIO TODAY.

Selectar connectors

★ Line of co-axial cable connectors suitable for all types of installations providing both gas and electrical connections. Various fittings for $\frac{3}{8}$, $\frac{5}{8}$, $\frac{3}{4}$, and $\frac{7}{8}$ " line. Selectar Mfg. Corp., 30 W. 15th, St, New York, N. Y.—RADIO TODAY.

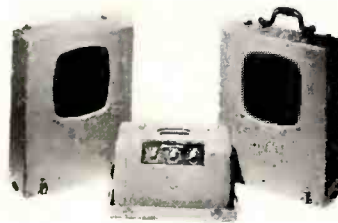

Webster-Chi PA system

★ Available in 3 power sizes, the portable PA system consists of amplifier, two 12 in. speakers, microphone and necessary connecting cable and is housed in single carry-

ing case. Webster-Chicago Corp., 5622 Bloomingdale Ave., Chicago, Ill.—RADIO TODAY.

Electrovox pickup

★ Electrovox Co. announces a featherweight phonograph pickup with permanent sapphire needle for installation on any manual phone. Point is said to be good for 15,000 records. Electrovox Co., 424 Madison Ave., N. Y. C.—RADIO TODAY.



Talk-a-Phone player

★ Record player and amplifier, G-51, has self-starting, rim drive motor, crystal pickup, built-in volume control. Plays 10 and 12 in. records with lid closed. Amplifier has 2-w. output, 3-tube inverse-feedback circuit, P.M. dynamic speaker. 110-120 v., 60 cycles, AC. Walnut veneer cabinet. Talk-a-Phone Mfg. Co., 1219 W. Van Buren, Chicago, Ill.—RADIO TODAY.

Belden soldering irons

★ Hexagonal soldering irons in 3-sizes, 80, 100 and 150 watt, each with a stand. Baffle plates keep "Easy-Grip" handle cool. Nichrome heating element. Belden Mfg. Co., 4689 W. Van Buren St., Chicago, Ill.—RADIO TODAY.



Knight tester transformer

★ Tube tester modernizer transformer with rotary switch gives extended filament voltages from 25 to 117 volts. Only two wires need be attached to tester and switch can be mounted in spare socket hole. Type B11689. Allied Radio Corp., 833 W. Jackson Blvd., Chicago.—RADIO TODAY.

New! **Fidelitone**
The Nationally Advertised
PHONOGRAPH NEEDLE

6 Months' Service from Each Needle
Retails for 50c



Filters Record Scratch
Through Floating Point . . .

Ask your Parts Distributor or write for full details . . . Made by the world's oldest and largest maker of long-playing needles.

Manufacturing  Metallurgists

PERMO PRODUCTS CORP.
6415 Ravenswood Ave., Chicago



"Pounding Back Each New Frontier"

"To attempt a forecast of the next ten years would be just as fruitless as would have been attempts ten years ago to picture the current uses of radio. The sequence of invention may carry it into far distant fields. Each adaptation of radio has meant a broader foundation upon which organized research may labor.

"What we may be sure of is not the nature of radio's future gifts, but that no hope of discovering a new service from it will be discarded and no promise of giving it greater public usefulness will be overlooked. The laboratory is pounding back each new frontier."

—FROM A STATEMENT MADE IN 1930 BY DAVID SARNOFF,
PRESIDENT OF RADIO CORPORATION OF AMERICA

THESE paragraphs above were written by Mr. Sarnoff ten years ago, as radio celebrated the tenth anniversary of broadcasting.

Now, in 1940, we commemorate the twentieth anniversary of this outstanding public service. During the last ten years, radio has progressed to a degree undreamed of in 1930.

It is possible that the progress of the next decade will be even

greater, as research brings new discoveries and manufacturing develops them for public use.

How far will that progress go? What direction will it take?

No one knows. But we who are close to radio must keep in mind one fundamental of radio's future—its measure of public service. On that foundation, it will progress and prosper beyond any conception we have today.

Radio Corporation of America

Radio City • New York

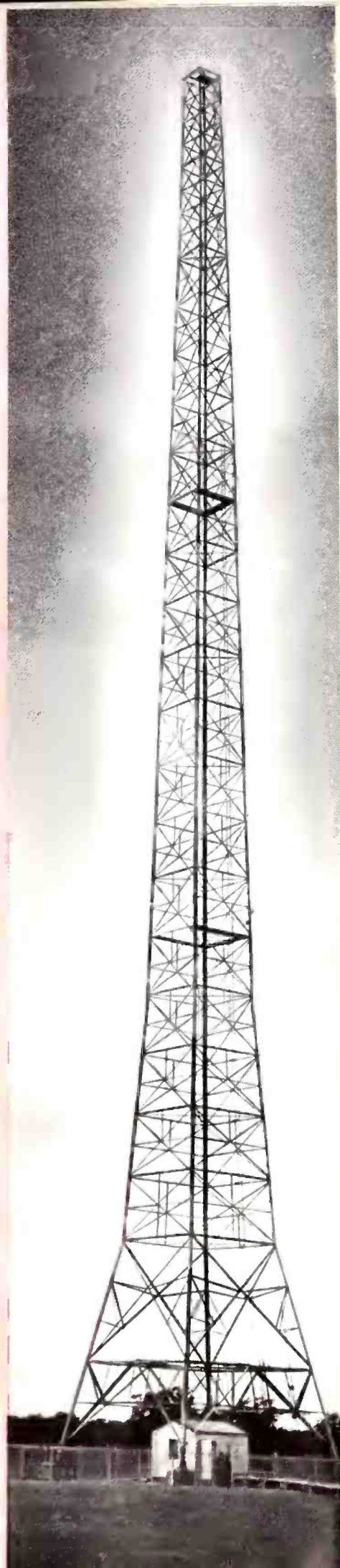

RCA Research is Radio's



With RECORDIO JUNIOR!

"A Recorder for the MILLIONS"

Sensational!

RECORDIO

HIGH

FIDELITY

RED LABEL

METAL DISCS



In a **FREE ALBUM!**

Below for complete details. Act now—today!

LOUISVILLE, KY.
 Rietze Distributing Company
 MADISON, WIS.
 Radio Parts Company
 MEMPHIS, TENN.
 Arthur Fulmer Company
 MILWAUKEE, WIS.
 Radio Parts Company
 MINNEAPOLIS, MINN.
 Tri-State Machinery Company
 NASHVILLE, TENN.
 Currey's, Inc.
 NEW HAVEN, CONN.
 Hatry & Young, Inc.
 NEW ORLEANS, LA.
 Shuler Supply Company
 NEW YORK CITY, N. Y.
 Carl Fischer Musical Instr. Co.
 OAKLAND, CAL.
 E. C. Wenger Company
 OKLAHOMA CITY, OKLA.
 Southern Sales Company
 OMAHA, NEBR.
 Radio Accessories Company
 ORLANDO, FLA.
 Radio Accessories Company
 PHILADELPHIA, PA.
 Elliott-Lewis Electrical Co.
 PHOENIX, ARIZONA
 Radio Specialties Company
 PITTSBURGH, PA.
 Tydings Company
 PORTLAND, ORE.
 F. B. Connelly Company
 RUGHBEEPSIE, N. Y.
 Poucher, Wood & Wallin, Inc.
 ROVIDENCE, R. I.
 I. Feldman Company
 RADING, PA.
 Geo. D. Barbey Company
 ROCHESTER, N. Y.
 Wehle Electric Company
 RUTLAND, VT.
 Vermont Electric Supply Co.
 SALT LAKE CITY, UTAH
 W. H. Blintz Company
 SAN ANTONIO, TEXAS
 Alamo Distributing Co.
 SCRANTON, PA.
 Scranton Radio & Television
 Supply
 SEATTLE, WASH.
 F. B. Connelly Company
 SIOUX FALLS, S. D.
 Power City Radio Company
 SOUTH BEND, IND.
 Radio Distributing Company
 SPOKANE, WASH.
 W. H. Dozier Company
 SPRINGFIELD, MASS.
 Milhender-Aies-Sang, Inc.
 ST. LOUIS, MO.
 Jenkins Music Company
 SYRACUSE, N. Y.
 Edward Joy Company
 TAMPA, FLA.
 Thurov Radio Distributors
 TERRE HAUTE, IND.
 Walker Electric Supply Company
 TOLEDO, OHIO
 Walding, Klannan & Marvin Co.
 UTICA, N. Y.
 Roberts Hardware Company
 WASHINGTON, D. C.
 Lincoln Sales Corporation
 WINSTON-SALEM, N. C.
 Brown-Rogers-Dixson Company
 YORK, PA.
 Strauss Distributing Company
 YOUNGSTOWN, OHIO
 Ross Radio Company
 ZANESVILLE, OHIO
 Thompson Radio Supplies

Here is a truly professional quality disc, safe for home recording, moderately priced—and each package of six is in a free album. Check these features:

PRICES	
including	
FREE ALBUM	
6½"	— 6 for \$1.00
8"	— 6 for 1.50
10"	— 6 for 2.00

- Low Initial Noise Level.
- High Fidelity at All Frequencies.
- Very Long Play-Back Life.
- Full Characteristics Maintained Under Extreme Temperature Conditions.
- Non-Inflammable.
- Unlimited Shelf Life.

Don't forget the standard composition base RECORDIO disc—still the lowest priced, high quality recording disc made anywhere.

HARLOTTE, MICHIGAN

WILCOX-GAY—MANUFACTURERS OF THE RECORDIO JUNIOR

RCA Research is Radio's



With RECORDIO JUNIOR!

"A Recorder for the **MILLIONS!**"

Sensational!

RECORDIO

HIGH

FIDELITY

RED LABEL

METAL DISCS

In a **FREE ALBUM!**



below for complete details. Act now—today!

LOUISVILLE, KY. Radio Distributing Company	RUTLAND, VT. Kermant Electric Supply Co.
MADISON, WIS. Radio Parts Company	SALT LAKE CITY, UTAH V. H. Britt Company
MEMPHIS, TENN. Alamo Distributing Company	SAN ANTONIO, TEXAS Alamo Distributing Co.
MINNEAPOLIS, MINN. Radio Parts Company	SCRANTON, PA. Scranton Radio & Television Supply
NASHVILLE, TENN. Tri-Slate Machinery Company	SEATTLE, WASH. S. B. Connelly Company
NEW HAVEN, CONN. Correy & Lee, Inc.	SIOUX FALLS, S. D. Faves City Radio Company
NEW ORLEANS, LA. Shapiro Supply Company	SOUTH BEND, IND. Radio Distributing Company
NEW YORK CITY, N. Y. Carl Meyer Musical Instr. Co.	SPRINGFIELD, MASS. Muller Sales-Serv. Inc.
OAKLAND, CAL. E. C. Weaver Company	ST. LOUIS, MO. Fountain Music Company
OKLAHOMA CITY, OKLA. Sovitch Sales Company	ST. PAUL, MINN. Edward Jay Company
OKLAHOMA, OKLA. Radio Accessories Company	TAMPA, FLA. Thompson Radio Distributors
PHILADELPHIA, PA. Radio Accessories Company	TEXAS Walton Electric Supply Company
PHOENIX, ARIZONA Ellis & Lewis Electrical Co.	TOLEDO, OHIO Walling, Smith & Martin Co.
PITTSBURGH, PA. Radio Specialties Company	UTICA, N. Y. Hoskins Hardware Company
PORTLAND, ORE. Tiffin Company	WASHINGTON, D. C. Radio Sales Corporation
POUGHKEEPSIE, N. Y. Foucher, Wood & Wallie, Inc.	WINSTON-SALEM, N. C. Brewer-Roper-Dixon Company
PROVIDENCE, R. I. R. L. Gardner Company	YOUNGSTOWN, OHIO Youngstown Distributing Company
ROCKFORD, ILL. Geo. D. Harber Company	ZANESVILLE, OHIO Hess Radio Company
ROCHESTER, N. Y. Wentz Electric Company	Thompson Radio Supplies

Here is a truly professional quality disc, safe for home recording, moderately priced—and each package of six is in a free album. Check these features:

- Low Initial Noise Level.
- High Fidelity at All Frequencies.
- Very Long Play-Back Life.
- Full Characteristics Maintained Under Extreme Temperature Conditions.
- Non-Inflammable.
- Unlimited Shelf Life.

Don't forget the standard composition base RECORDIO disc—still the lowest priced, high quality recording disc made anywhere.

PRICES
including
FREE ALBUM

6 1/2" — 6 for \$1.00
8" — 6 for 1.50
10" — 6 for 2.00

CHARLOTTE, MICHIGAN

WILCOX-GAY—MANUFACTURERS OF THE RECORDIO JUNIOR

RECORDS GOING AS GIFTS

Dealers are now confronted with special excitement in the business of selling records as Christmas gifts.

Hundreds of record players and combinations have come into use since last year, and thousands of new record fans will be exchanging gifts.

The season would be a tip-top one, even without the terrific advantage of the new retail prices. But the fact is that the lower-price policies announced by the manufacturers will boost the business to new highs and will help to make the 1940 holiday profits for the retailer a matter of smashing importance.

To handle all this extra business, the dealers are now making final checks on the condition of their complete record-selling facilities. The matters being considered are (1) Have I stocked a full variety of discs, including all the different types that will sell this year? (2) Have I organized my ideas on exactly *who* will buy each kind of record? and (3) Am I ready with all the merchandising tools that will be useful in getting the records to the buyers who want them?

For the check-up on complete stocks as to the various kinds of records, here are the major groups that should be on hand, besides the regular run of releases:

- Children's Records
- Christmas Music
- New Symphonies
- Swing Classics
- Patriotic Discs
- Extra Albums
- Collector's Numbers
- Opera Selections
- Dance Favorites
- Fun-making Novelties
- Recorded Programs
- Foreign Music

Plenty of dealers have made a good thing out of educational records and those dealing with language training, but the above groups are listed as the best bets for gift promotion.

Now, as for the prospects who are to be approached with the Christmas news about the above records. The list might include old customers, buyers of other products, recent purchasers of record-players, etc., but for holiday promotion the following are specifically worth a separate merchandising stunt this year:

- Collegiate Groups
- Youngsters
- Musical Homes
- Dance Fans
- Professional Musicians
- Students
- Collectors
- Foreign Groups

When these people are alertly contacted with the particular record releases which are appropriate for gift-giving in their special circles, dealers find that their merchandising effort pays off.

The next question is *how* to reach all the prospects, with all the records. The final check-up on selling tools means that the dealer will check to see that all of the following are on hand:

- Album Gift Trims
- Record Gift Certificates
- Christmas Music Background
- New Window Displays
- New Releases as Gift Suggestions
- Holiday Direct Mail
- Fresh Displays in Store

Any of the above stunts may be profitably prefaced with a brand new announcement of the reductions in record prices.



Here's the popular record artist, Lou Breese, in action. He's now a central figure in a big contest to select a girl vocalist for his band. It means extra business for home recording dealers; recorded entries must be made on blanks made by RecorDisc Corp., 395 Broadway, NYC.

Record Changers Get a Play

"Automatic record changers, the improved ones which are now offered at popular prices, fit in with every modern trend you can think of," says B. G. Geller, of Bloomfield's, the well known record shop on 14th St. in New York City. Mr. Geller has been merchandising records for 20 years, and he knows a sales trend when he sees it. He declares that the extra convenience and the sure-fire efficiency of the new record-changing units make them an extra good sales bet, these days.

As the record buyers, old and new, troop into Bloomfield's, Mr. Geller and his salesmen are ready with the story on changers. Due to the fact that nearly everyone is somewhat lazy, the talk nets sales. The experienced record fans know well enough that there's a lot of fatigue in changing records manually; newcomers want to start right.

Wax Worth Watching

LEO REISMAN and his orchestra playing Down Argentine Way from the 20th Century Fox film, with VR by Sara Horn—Victor 26765.

DEANNA DURBIN with orchestra singing Waltzing in the Clouds from the Universal film, "Spring Parade"—Decca 3414.

WILL BRADLEY and his orchestra playing Rock-A-Bye Boogie—Columbia 35732.

ANDREWS SISTERS singing Beat Me Daddy—Decca 3375.

INK SPOTS singing My Greatest Mistake—Decca 3379.

WAYNE KING and his orchestra playing You Are My Sunshine with VR by trio and Mr. King—Victor 26737.

MARY SMALL with orchestra singing Some of These Days—Okeh 5794.

ORRIN TUCKER and his orchestra playing You're Nearer from "Too Many Girls" with VC by Jack Bartell—Columbia 35792.

(More news on records, recorders, p. 67)

This "Giftcheck" is being printed in red and green, to help dealers' selling records as gifts. Books of them come from Alex A. Gettlin, 1616 Walnut St., Philadelphia.

Dec 20, 1940		DEALER'S NAME		No 10004	
		107 MAIN STREET			
		Telephone			
Pay to the	Eddie Bennett				
Order of					
	PHONOGRAPH RECORDS				
in amount of	Five		DOLLARS.		50
A Merry Christmas and		Nancy Ford			
A Happy New Year					

DEWALD

proudly presents

"COMPANIONETTE"

4 pounds of the greatest miniature radio ever presented to the public

An elegantly streamlined PERSONAL Radio that goes everywhere and does everything a high grade set is expected to do. BEAUTY and PERFORMANCE at a modest price, so that both the radio and the price will make more friends for YOU!

Four tube super-het circuit, simulated cowhide case (saddle-stitched).



Since 1921 DeWald has been a leader in STYLE, DESIGN AND PERFORMANCE. Complete new line \$9.95 to \$175.

JOBBERS—Write for details of new profit-making merchandise plan

DeWald Radio Mfg. Corp.

440 LAFAYETTE STREET NEW YORK CITY
CHICAGO—6526 San Francisco, Chicago, Illinois

HOME-RECORDER TRADE Comes Easy With THIS SIMPLIFIED UNIT

New!
GI-R70



Easy to
INSTALL

Easy to
OPERATE

Easy to
SELL!

POPULAR-PRICED home recorders will get you lots of profitable sales to average musical families that have "only been waiting for the price to come down." Start your assemblies with the up-to-date, low-cost General Industries GI-R70 unit—it gives your customers first-quality recording, besides saving on cost. Unit consists of precision-made cutting head and arm with depth adjustment; high-quality tangent-tracking crystal pick-up; weighted turnable with retractable record-driving pin; big, special-design rim-drive motor. Mounted, ready to install. Made by the world's largest manufacturer of phonograph motors.

Order a GI-R70 to test

The **GENERAL INDUSTRIES CO.**

Dept. 438

Elyria, Ohio



STAKE YOUR CLAIM *Now*

To a Share in Today's
Great Untapped Market

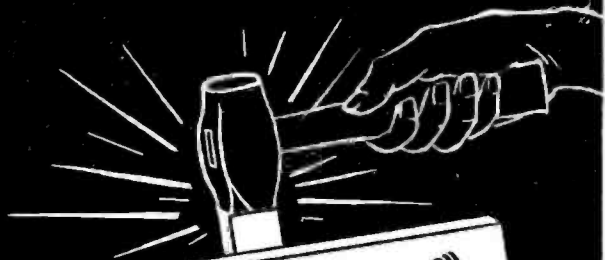

ROCK-OLA
Recorders & Discs



● The appeal of home recording is universal. Parents, young people, children . . . teachers, students . . . everybody will want to make records whenever they wish—once they find out how entertaining and educational, how easy and economical this new-day development really is. There's your market for record-breaking sales this season—and it's practically untouched! Introduce home record making to the prospects in your community with Rock-Ola Recorders and Discs—the line that lets you offer the most in features, in quality and appearance. Go after the extra profit that's yours for going after tomorrow's market today.

8 RECORDER MODELS

Made specially for home recording. 6 consoles in modern and period designs, a table console and a portable. Priced (list) from \$59.95 to \$169.95. Model illustrated is Model RA-3 Table Console, \$69.95.

ROCK-OLA DISCS—

Insure finest performance—high fidelity recordings, minimum surface noise, maximum play-backs. Slow burning. Competitively priced. 6½, 8 and 10 inch.

Get full details on Rock-Ola's attractive dealer plan from your Rock-Ola distributor—write us for his name. Address Dept. RT-11.



ROCK-OLA MFG. CORPORATION

800 N. Kedzie Ave., Chicago, Ill.

HOLIDAY SOUND SALES



Community sound system installed in Beckley, W. Va., by Robert Sweeney, local distributor, delivers holiday music to townfolk.

Christmas jobs for sound men offer real prospects for yearly jobs. How to work-in your election equipment.

November and December are months of holiday activity and "open season" on sound jobs. There are lots of places where your election PA equipment will fit in with jobs for the next two months, so don't waste any time switching over to the many jobs originating in the next two months.

Merchants are getting prepared to handle the largest and most "high geared" sales peak of the entire year. Cities and towns are preparing plans for celebrations at Thanksgiving, Christmas, and New Year's. Football is at the peak of its season. Churches and schools are organizing pageants, plays, and other progress. Here is an unlimited field for public address applications. Contact about a dozen prospects now for your share of the PA work.

HANGING UP SPEAKERS

Each year, progressive store keepers, merchants, and business men plan their selling action around some holiday civic activity—parades, lucky number drawings, guessing contests. Streets are decorated and sound equipment is a necessity for spreading around the season cheer.

The way to line up these jobs is as follows:

1. Get the local newspapers behind the idea of a giant Christmas celebration

with all the necessary stimulation provided by giving away merchandise through drawings, contests, etc.

2. Propose to the merchants along the main streets of the town that they rent suitable public address equipment for installation in front of their stores to play Christmas carols, give announcements, and advertise holiday gift merchandise.

3. Work up the system so that it may be tied in with the city sound job used at the Court house or around the community Christmas tree. This will give "extra coverage" for the merchants.

TYPICAL JOB

Each year, on the day after Thanksgiving, the Beckley, W. Va. merchants officially open their Christmas shopping season. The opening is held this early for numerous reasons; to start the buying season off earlier, resulting in more Christmas business. Everything is done to stimulate the Christmas spirit and increase gift buying. This opening day is celebrated with a Santa Claus parade; laurel, wreaths and colored lights decorate the streets. But, of course, they do not leave it to one day's celebration and that's where Robert D. Sweeney of Sweeney's Radio Parts Distributors comes into the picture with a city-wide sound system.

Beckley is a town of 15,000 in the

heart of the great Smokeless Coal fields.

Last year 41 Atlas Sound Corp. Marine type speakers were scattered about the streets mounted 14 or 15 feet above the sidewalks on the light posts. Previously, the merchants had installed two or three power speakers at strategic points in the city. This furnished the Christmas music but of necessity had to be too loud in one spot to cover the streets well.

EFFICIENT SYSTEM

Bob Sweeney suggested dozens of smaller speakers and a main 40 watt amplifier. The system worked to perfection. Shoppers were tripping along main streets in the busy city to the tunes such as Jingle Bells. The music was not harsh, nor irritating to storeworkers who were right under a speaker, the sound distribution was perfect and many requests came in asking that the city be sure to have the Christmas music again this year.

The system acts as a medium through which announcements can be made relative to programs, civic events, reminding shoppers how many days are left, etc. However, no merchant individually is permitted to have his name mentioned or commercialized in any manner whatsoever regardless of what he donates or gives. It is strictly a community project and is kept as such.

More than 10,000 feet of wire was used in the installation. The speakers were mounted on the metal light poles with common strap iron.

MORE OUTLETS

This year, 20 more speakers will be added to the 41 used before. There will be 3,000 feet of additional wire used.

Here is the way the system was financed. The local merchants organization, Beckley Mercantile Board, purchased the whole outfit outright. Mr. Sweeney installs it each year and takes care of storage. There is an allotment in the Christmas budget each year to pay his fee and take care of extra material needed and repairs if any. This means a nice job each November.

The amplifier is located in the center of town; last year it was placed in the Credit Bureau offices and the force there kept music going at all times, even up into the night.

NEW LEADS

The music consisted of Jingle Bells, Silent Night, Christmas Carols, Storybook songs, and popular music. Each store in town handling records sent in discs to be used and moreover, folk about town would bring down certain records to be played.



Florida Orange Bowl has Atlas speakers. Job by Flagler Radio Co., Miami.

The office of the Credit Bureau was almost a studio at times. The local glee clubs, church choirs, high school bands and such other organizations came down on certain evenings to broadcast. Good equipment made the broadcasts highly successful.

DEPARTMENT STORES

Hinton, a neighboring city, 25 miles distant has approached Mr. Sweeney to make an installation for them this year.

The local merchants unanimously agree that nothing builds Christmas spirit, softens the hearts, breaks down sales resistance and opens the purses of buyers like music and this is just what they received in copious and constant doses.

Even though all other Christmas promotions may be abandoned by Beckley merchants you can be sure they're going to hang onto this system and have it in each year.

Department stores will feature their

program during Christmas with the aid of sound. Speakers mounted along the front of stores will be used for amplifying chimes, carols, and other holiday programs. The toy departments will have Santa Claus shows and demonstrations where small PA units can be used effectively. Here is the place to work in your election equipment. Two or three small amplifying systems can be used around the larger department stores, especially the combination phonograph amplifier jobs.

The outdoor speakers are usually mounted along the face of the building about ten feet above the ground. Five-watt units are large enough unless the street noise level is unusually high. Use as few speakers in series as possible to prevent complete loss of output due to one speaker opening up. Weatherproof horns of the wide angle type will be best for most installations. Such an installation will be ideal for window demonstrations of appliances, radios, toys, and many other items lend themselves.

Community holiday programs, especially in the smaller towns, are whole heartedly taken part in by the citizens. Local sound men can fit right into the picture. Suggest to the Chamber of Commerce that a huge Santa Claus be built, and "wired for sound." This will lend itself to many trick arrangements with sound equipment. Santa can answer questions, direct the handing out of presents to the kids, etc. By installing a two-way intercommunication system with the talk-listen control located at the remote end, lots of fun could be had with question answering schemes.

WINTER SPORTS

The football season is reaching its climax and there are but few sound jobs left for most of the local schools. If there are several more games still scheduled at a high school, or college in your territory it will be well worth making the contacts necessary to get

your equipment a try. A proof of its workability will put you in good for next years' games and for the other sporting events to be held this winter and next spring.

Small school football games are usually run quite a bit different than their larger cousins, especially in the PA end of the business. The one or more designated "down by down" reporters usually get so worked up over the results that they run up and down the side lines with the play. The best position for your equipment is usually about the 50-yard line. At least a mike pre-amplifier should be located at about this position. Use plenty of mike cable. Don't worry about the frequency response being cut down by the longer cable, voice frequencies are low enough to be un-affected. A good sturdy mike is to be recommended. Mount your speakers up high and use as many as possible.

CHURCH INSTALLATIONS

Church sound systems will be put to good use during the Christmas season with all the special programs arranged for this period. The way to get a church sound job is to talk to members of the congregation about the sections of the church where they have trouble hearing the services. After you have talked to several members, go to the church board and ask to place a public address unit in without charge for demonstration. This should be a simple but effective installation using a good quality system. Since you have identified the places that are "dead" you can place your speakers to advantage. One or two trials with the equipment should just about sell the idea of good sound re-inforcement.

After you have shown what a temporary installation can do, draw up plans for a complete system, using hearing-aid equipment, phonograph or tubular chimes, and tower speakers. Use good equipment and install it so that the job will be a continuous advertisement of your PA ability.

Speaker layout used in Beckley, W. Va., community Christmas sound system. Solid symbols represent speakers used last year while open symbols show location and number of new outlets added for this year.

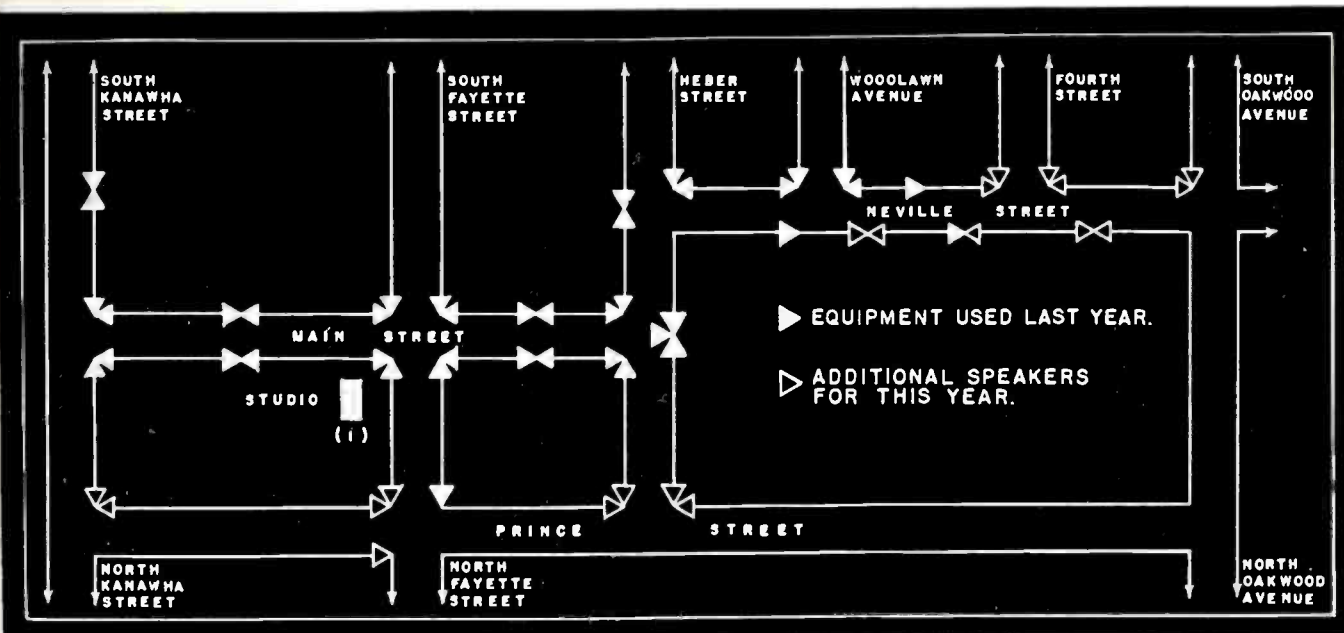

*Here's the one you have
been waiting for!*



This "different" Meissner Portable
PHONO-RECORDER
can bring YOU extra profits!

Whether you are a Jobber, Dealer-Serviceman or Sound Technician, this new Meissner Portable Phono-Recorder should be the means of putting extra money in your pocket!

Its outstanding high quality, professional appearance and operation, fidelity of recording and reproduction, facility and flexibility in handling all sizes of records up to 12"—plus its additional features including its use as an auxiliary P-A System for small groups, make its demonstration and sale almost a matter of form in many widely variant fields.

Housed in an attractive airplane-luggage case, only 16" x 17" x 7", this instrument is readily handled on any kind of job. Contains built-in, high-quality audio amplifier, complete with tubes; space for crystal mike and power cord inside case; record storage space conveniently placed inside demountable cover. Operates directly from any 110-volt, 60-cycle power line. Sturdy 6" dynamic speaker furnishes full volume output on reproduction or P-A use, without distortion.

Fully equipped with complete control equipment for making high-grade recordings—Volume Control, Tone Control, Selector Switch for Recording, P-A and Reproduction, Normal and Overload Indicators; provided with first quality magnetic cutting head and wide-range crystal pick-up. Furnished with combination hand-and-stand crystal microphone.

Nothing has been overlooked to make this unit the real leader of the field in quality performance! And yet the price has been held to an encouragingly low level—only \$59.50 list, subject to usual Jobber and Dealer discounts!

Write for Your Free Copy of the New Meissner General Catalog!



ADDRESS DEPT. T-11

SOUND

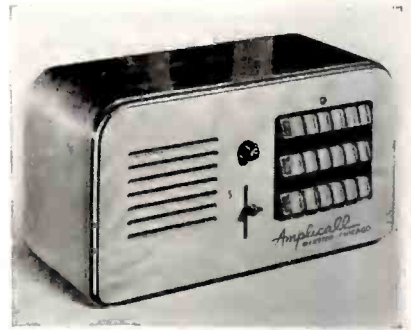

Webster-Chicago W300

★ Combination paging and intercommunicator. Central master station can page any or all remote stations or carry on 2-way communication with each station. Remote stations can originate calls. Master control housed in 2-toned birch and walnut cabinet. Push button selector. Maximum facilities 18 remote stations, maximum power 25 w. Webster-Chicago Corp., 5622 Bloomingdale Ave., Chicago, Ill.—RADIO TODAY.



Shure Stratoliner

★ Model 708A crystal mike in gray and chrome case. Semi-directional or non-directional. Swivel head, built-in cable connector. Output level, 49.7 db below 1 volt per bar. 7 ft. conductor. \$17.50. Shure Bros., 225 W. Huron St., Chicago, Ill.—RADIO TODAY.

University model RLP



PARTS

★ New "lighthouse" radial projector takes all types of 12-inch cone speakers. Greater acoustic length is used to increase low frequency reproduction. Three non-resonant rubber tire rims, heavy aluminum spinning, floating rubber speaker mounting. 360 degree distribution. 24-inch diameter, 28 inches long. University Laboratories, 195 Chrystie St., New York, N. Y.—RADIO TODAY.



Dynamic reproducer

★ Sound Apparatus electro dynamic pickup has 30 to 9,000 cycles frequency response, 1 oz. or less needle pressure, low needle impedance, 200 ohms impedance. Sound Apparatus Co., 150 W. 46th St., N. Y. C.—RADIO TODAY.

Walsco staple

★ New type steel staple used with Walsco driver, can be driven into extremely hard surfaces. 29c. net for box of 230 staples. Walter L. Schott Co., 5264 W. Pico Blvd., Los Angeles, Calif.—RADIO TODAY.



Clarion record changer

★ Portable automatic record changer-amplifier combo, model C-182 plays twelve 10 or 12 in. records intermixed and provides for rejecting any records not desired. Oscillator permits playing records through any nearby radio set. 6 in. PM speaker, 2-tube high-gain amplifier. Airplane Pyro-tweed leatherette. \$62.95. Transformer Corp. of America, 69 Wooster St., N. Y. C.—RADIO TODAY.

FEATHERWEIGHT PRESSURE LIGHTENS THE BURDEN OF SELLING

RECORDS LAST A LIFETIME

Astatic Low Pressure Crystal Pickups exert only one-ounce stylus pressure on the record, scarcely more than one-third the conventional weight. Records retain newness indefinitely.

ELIMINATES NEEDLE CHANGING

Astatic Low Pressure Crystal Pickups are supplied with permanent, built-in, sapphire styli, maintaining their highly polished and accurate contour indefinitely.

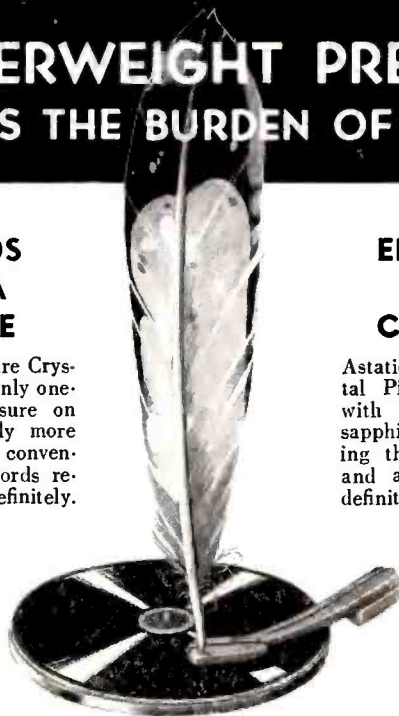

ASTATIC Model
FP-18 Low Pressure
Crystal
Pickup. List Price
\$16.50

Single hole mounting and simple hook up assure easy installation.

THERE'S A BIG MARKET FOR ASTATIC *Low Pressure* PICKUPS

• All radio and electrical shops, department and chain stores, music houses and other places where phonograph records are demonstrated and sold, furnish a fertile market for Astatic's new Low Pressure Pickups. Here is a pickup arm with permanent sapphire stylus that not only eliminates the buying and changing of needles, but provides greater fidelity of reproduction without surface noise and distortion. Stock records under conventional needle pressure become "used records" with a single playing. By reducing wear, stock records remain like new regardless of the number of times they may be demonstrated. Stop for a moment and think what an advantage and convenience this will be to those retail dealers in your territory, who demonstrate and sell records, and the sales opportunities it offers you today. This is new business. Get it.

Literature and displays are available. Tell us your needs.



ASTATIC MICROPHONE

IN CANADA: CANADIAN
ASTATIC Ltd., TORONTO, ONT.

YOUNGSTOWN
OHIO



ASTATIC CRYSTAL PRODUCTS LICENSED UNDER BRUSH DEVELOPMENT CO. PATENTS

Here's the one you have
been waiting for!



This "different" Meissner Portable
PHONO-RECORDER
can bring YOU extra profits!

Whether you are a Jobber, Dealer-Serviceman or Sound Technician, this new Meissner Portable Phono-Recorder should be the means of putting extra money in your pocket! Its outstanding high quality, professional appearance and operation, fidelity of recording and reproduction, facility and flexibility in handling all sizes of records up to 12"—plus its additional features including its use as an auxiliary P.A. System for small groups, make its demonstration and sale almost a matter of form in many widely variant fields.

Housed in an attractive airplane-luggage case, only 16" x 17" x 7", this instrument is readily handled on any kind of job. Contains built-in, high-quality audio amplifier, complete with tubes; space for crystal mike and power cord inside case; record storage space conveniently placed inside detachable cover. Operates directly from any 110-volt, 60-cycle power line. Sturdy 6" dynamic speaker furnishes full volume output on reproduction or P.A. use, without distortion.

Fully equipped with complete control equipment for making hiss-free recordings—Volume Control, Tone Control, Selector Switch for Recording, P.A. and Reproduction, Normal and Overload Indicators; provided with first quality magnetic cutting head and wide-range crystal pick-up. Furnished with combination hand-and-stand crystal microphone.

Nothing has been overlooked to make this unit the real leader of its field in quality performance! And yet the price has been held to an encouragingly low level—only \$59.50 list, subject to usual Jobber and Dealer discounts!

Write for Your Free Copy of the New Meissner General Catalog!



SOUND PARTS



Webster-Chicago W300

★ Combination paging and inter-communicator. Central master station can page any or all remote stations or carry on 2-way communication with each station. Remote stations can originate calls. Master control housed in 2-toned birch and walnut cabinet. Push button selector. Maximum facilities 18 remote stations, maximum power 25 w. Webster-Chicago Corp., 5622 Bloomington Ave., Chicago, Ill.—Radio Today.



Shure Strotoliner

★ Model 708A crystal mike in gray and chrome case. Semi-directional or non-directional. Swivel head, built-in cable connector. Output level, 49.7 db below 1 volt per bar, 7 ft. conductor. \$17.50. Shure Bros., 225 W. Huron St., Chicago, Ill.—Radio Today.

University model RLP



RADIO TODAY

★ New "lighthouse" radial projector takes all types of 12-inch cone speakers. Greater acoustic length is used to increase low frequency reproduction. Three non-resonant rubber tire rims, heavy aluminum spinning, floating rubber speaker mounting, 360 degree distribution. 24-inch diameter, 28 inches long. University Laboratories, 195 Christie St., New York, N. Y.—Radio Today.



Dymonic reproducer

★ Sound Apparatus electro dynamic pickup has 30 to 8,000 cycles frequency response, 1 oz. or less needle pressure, low needle impedance, 200 ohms impedance. Sound Apparatus Co., 150 W. 46th St., N. Y. C.—Radio Today.

Waisco staple

★ New type steel staple used with Waisco driver, can be driven into extremely hard surfaces, 25c. net for box of 250 staples. Walter L. Schott Co., 5264 W. Pico Blvd., Los Angeles, Calif.—Radio Today.



Clarion record changer

★ Portable automatic record changer-amplifier combo, model C-182 plays twelve 10 or 12 in. records intermixed and provides for selecting any records not desired. Oscillator permits playing records through any nearby radio set, 6 in. PM speaker, 2-tube high-gain amplifier, Airplane Proof-wed leather, etc. \$82.95. Transformer Corp. of America, 69 Wooster St., N. Y. C.—Radio Today.

NOVEMBER, 1940

FEATHERWEIGHT PRESSURE LIGHTENS THE BURDEN OF SELLING

RECORDS LAST A LIFETIME

Astatic Low Pressure Crystal Pickups exert only one-ounce stylus pressure on the record, scarcely more than one-third the conventional weight. Records retain newness indefinitely.

ASTATIC Model
FP-18 Low Pressure
Crystal
Pickup. List Price
\$16.50

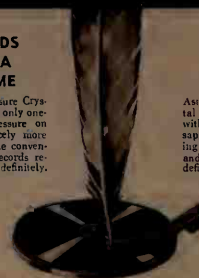

ELIMINATES NEEDLE CHANGING

Astatic Low Pressure Crystal Pickups are supplied with permanent, built-in, sapphire stylus, maintaining their highly polished and accurate contour indefinitely.

Single hole mounting and simple hook-up assure easy installation.

THERE'S A BIG MARKET FOR ASTATIC Low Pressure PICKUPS

• All radio and electrical shops, department and chain stores, music houses and other places where phonograph records are demonstrated and sold, furnish a fertile market for Astatic's new Low Pressure Pickups. Here is a pickup arm with permanent sapphire stylus that not only eliminates the buying and changing of needles, but provides greater fidelity of reproduction without surface noise and distortion. Stock records under conventional needle pressure become "used records" with a single playing. By reducing wear, stock records remain like new regardless of the number of times they may be demonstrated. Stop for a moment and think what an advantage and convenience this will be to those retail dealers in your territory, who demonstrate and sell records, and the sales opportunities it offers you today. This is new business. Get it.

Literature and displays are available. Tell us your needs.



ASTATIC CRYSTAL PRODUCTS LICENSED UNDER BRUSH DEVELOPMENT CO. PATENTS

SERVICING INTERMITTENTS

Methods and tricks to use in finding faulty parts which cause periodic operation

Intermittent set faults hold first place among pet peeves of servicemen, and are not much more welcome to set owners. In the September issue of RADIO TODAY, a broad view of the customer relation angle on intermittent repairs was given. Other views on this angle from servicemen will be published as mutual help.

Intermittent reception is a broad term which includes fading, slow and rapid, static-like noises which are due to set or antenna-ground faults. All of these troubles may be considered akin and a common procedure can be used for hunting them.

Intermittents are not difficult to recognize as a type of trouble, but there may be a problem deciding whether the trouble is in the set or elsewhere. Antenna, ground, or the AC line may be the cause.

EXTERNAL FAULTS

The aerial system should be the first point of inspection when tackling an intermittent case. Connections from the far end of the wire to the set must be really given a "going over." Wrap-arounds are not good enough. Every joint should be soldered securely. Lightning arresters are a particular source of intermittents or noise. The bolts passing through the porcelain housing loosen through expansion and contraction, sometimes permitting the two gap blades to touch—result, plenty of noise and intermittents.

Ground leads, too, are subjects for suspicion. Large variations in ground resistance cannot be tolerated. Connections to the water pipe should be close to the entrance into the ground

to avoid as many joints in the pipe as possible, as these are usually painted and have considerable resistance. Grounds in extremely dry locations, formed by driving rods or pipes into the earth, may be improved by saturating the soil with a salt-water solution. Replace badly rusted, loose clamps.

The power line and house wiring is, many times, the cause of the intermittent operation of the set.

POWER LINE GROUND

Bad connections, loose bulbs, fuses and other appliances are many times the cause of intermittents. Wiring may be loose at outlet plates, or elsewhere in the house. Such conditions may be observed with a light connected to the radio outlet. Use a low wattage bulb and watch for flickering.

One of the worst power line intermittents is due to the varying ground path between the set and earth. A set playing at normal volume level will suddenly become twice as loud or cut off altogether as some appliance is turned on elsewhere in the house. This usually occurs when radio and appliance are on the same branch circuit. The reason for this remote and undesired volume control is a poor ground on the set. As lights or other electrical devices are paralleled across the line, the impedance path to ground is reduced, thus boosting the signal. AC sets are subject to this sort of trouble more than the AC/DC variety. The reason being, that AC/DC sets are connected directly to the line, while AC sets are isolated by the transformer. A cure may be effected by placing two 0.01 mfd. paper capacitors in series across

the AC line-side of the power transformer and connecting the junction of the condensers to the chassis of the set. A good separate set-ground may be needed in stubborn cases.

After the preliminary investigation of the antenna, ground, and power line has been made, the next step should be the testing of the tubes, especially for shorts while hot. Any that are even slightly suspicious should be temporarily replaced as a test. Tubes with indirectly heated cathodes are usually the ones to cause trouble rather than the filament types.

SPOTTING TROUBLES

The obvious method to use in speeding up intermittent searches, is that of identifying certain characteristic types of action at particular points in the circuit. Intermittents ahead of the second detector will affect the AVC circuits, while those in the audio section will not unless shorts change tube voltages. Intermittents in circuits ahead of the volume control will be varied in volume, while those "back" of control will not. For example, this is the method of distinguishing IF transformer failure from audio transformer breakdown. The type of crackling noise is exactly the same, but audio transformers are generally located after the volume control and, therefore, don't have their ailing varied in strength by the control.

VOLTAGE BOOSTING

Faults producing intermittents may occur in any portion of the circuit. Parts which have screen or plate DC voltages on them are usually the ones which cause intermittent operation of the set. These parts may be weak and break down at some crucial moment when the line voltage, and consequently the DC operating voltage rises. For this reason, the location of these faulty parts may be speeded up by boosting the over-all voltage on the set until the erring condenser, resistor, transformer, etc., is broken down permanently. This process may take a few innocent parts with it, but the result will be a better set, since those weaker sisters will be out.

For this work, some sort of auto-transformer will be handy. The line voltage may be raised about 10 per cent from the usual value under which the set was working. Breakdowns may not be due to the higher voltage alone, but also the rate of rise of voltage. For this reason, the line voltage should be "jogged" with the auto-transformer.

Particular things to examine as possible sources of intermittents are screen and plate circuit by-pass condensers, bad connections, open IF or

Some of the more common causes of intermittents and fading. Parts labeled I are sources of intermittents and those marked F cause fading. Their effects are sometimes reversed

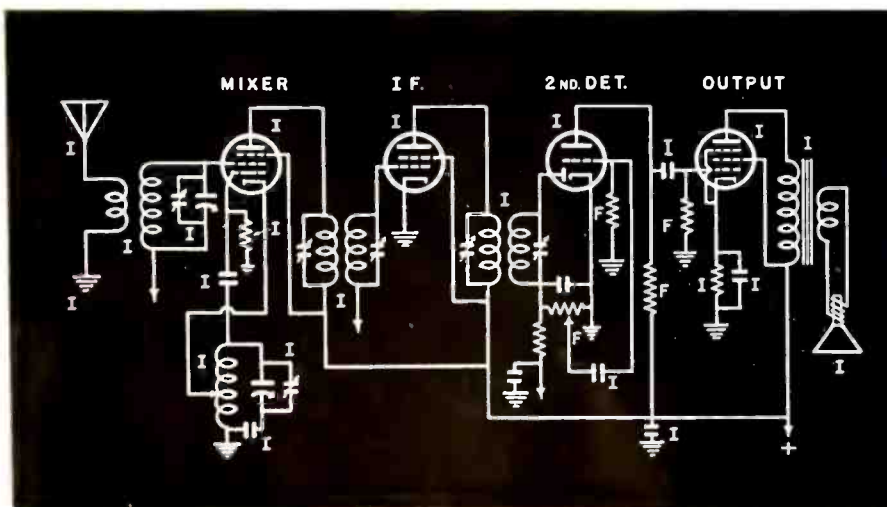

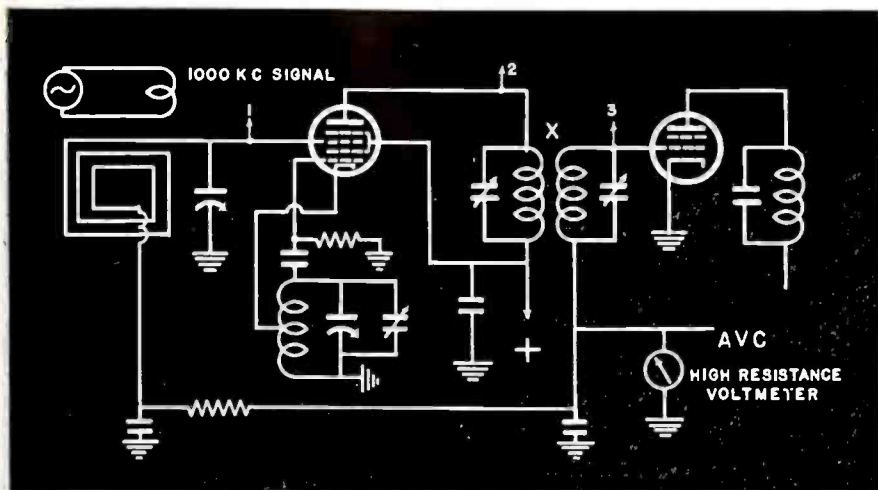

Basic method for locating intermittent with signal tracing. Signal is picked up at 1 and 2 OK. Varying signal at 3 indicates faulty IF transformer. Other sections checked similarly.

audio transformers, breakdown of high value resistors. Interstage coupling capacitors, especially in the audio section, are a major cause of intermittents. The usual complaint is due to connecting leads breaking off from the foil, but with no external indication. Give these a little axial exercising.

POWER SUPPLY FAILURES

Power supply failures that occur intermittently will present themselves by varying the current drain of the set and the wattage input. This is also the case of by-pass units which are a part of the DC power network. A power line wattmeter or other indicator is valuable as an indicator of this trouble. If such an instrument is not at hand, a substitute may be rigged up with a 25-ohm 100-watt resistor in series with an outlet receptacle. The resistor should be of the semi-variable type. Connect your AC voltmeter across the resistor and adjust the slider until approximately two volts drop is obtained with the set plugged into the outlet. Any change in the power input to the set through shorts or opens in the circuits will show up on the meter. The device may be calibrated into watts. Watts equal to E^2/R .

Intermittents are almost always tied up with a change in heat. When sets are brought into the shop, they should be left in the cabinet while operating runs are made. Wrap the set in heavy canvas or other slow-burning material to boost the temperature in the set. Condenser failures which cause intermittents will be broken down completely in the extra heat.

FADING TROUBLES

Slow fading is just as much a form of intermittents as the complete cut-off variety. Slow fading will usually be found due to changes in resistance of volume controls, bias resistors, and plate load resistors. Heat is the major factor in changing the value of resistors. Picking out the one which is giving the trouble will be a job in more complex receivers. Here again, the methods of observing other circuit variations can be used to advantage. Variations in the AVC bias, or second detector plate current, will in-

dicate the trouble to be in the RF portions, of course. It is possible that an RF or IF tube screen-dropping resistors are changing value and the amplification of the signal.

Extra heat is often applied to hasten or completely break down parts causing intermittents. Methods of applying the heat range from use of a soldering iron near the part to the small alcohol blow-torch. A wire gauze or screen should be used between the flame and the part when the torch is employed. Do not let the open flame come in contact with any of the set parts. These tricks all require skill and care, but will often be valuable in hastening the breakdown of faulty parts.

USING THE SIGNAL

One of the advantages of signal tracing equipment is its use in hunting intermittents. By monitoring several vital parts of the receiver circuit at one time, any breakdown may be localized into one of these sections. Further and detailed testing of the parts in that section of the circuit locate the troubles.

Signal substitution is easily applied to intermittent hunting. Connect your oscillator so that it delivers a signal of the correct frequency to the sus-

pected stage or stages. The output meter connected in its usual way will show the intermittents and slow fading. By moving the signal toward or away from the output meter, the trouble is localized. Coupling condensers, RF and IF transformers are checked by putting the signal generator before and after the part while noting the action of the output meter. By-pass condensers in screen and cathode circuits must really do their job when the signal is applied to these circuits. A marked increase in the output will indicate that they are not working. Well shielded oscillator probes are needed to prevent excessive radiation to the grid circuit which would cause greater output and give a false indication.

REMOVE SUSPECTED PARTS

Where individual parts are suspected of causing the intermittents, they are more completely tested after they have been removed from the circuit. Capacity is easily checked while connected in the circuit by many testers described in other issues of RADIO TODAY. However, more than a capacity test is usually necessary. The leakage current at 10 to 20 per cent more than normal operating voltage should be measured while the capacitor is kept at a temperature equal to operating conditions. At least one tester of condensers puts a strong RF current through them to measure their impedance as well as capacity. Any capacitor which has a loose connection internally will be quickly broken down with the heavy current.

Noisy IF and RF transformers can be checked by putting a few mills of DC through each winding while listening to a pair of headphones attached to the free winding. Any noise will indicate that the winding connected to the DC is at fault because of a damaged winding or moisture. Remember that IF transformer windings usually have only about 10 ohms resistance, therefore, a DC test voltage should be quite low and a protective resistance used in series to prevent destroying the winding.

USE A SYSTEM

While intermittent troubles are sometimes the most difficult to clear up, the development of a system for

(Continued on page 56)

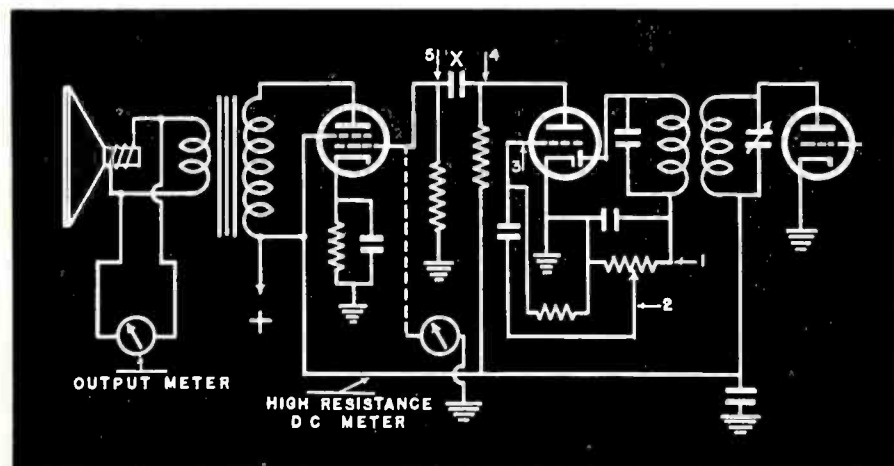

SERVICE INTERMITTENTS

(Continued from page 55)

going after these faults will make the jobs simpler. The following is suggested as a guide to be so modified as is necessary to fit your particular equipment, etc.

First, examine the antenna, ground, and power line for loose connections, and high resistance grounds.

Second, check tubes, especially for shorts while they are hot and being tapped to vibrate the elements. Cathode leakage tests are also very important.

Third, attempt to localize the intermittent part by making a few checks of the AVC, or second detector cathode current, and whether the volume control has any effect on the occurrence and volume of the intermittents. Have the set operate for some time in its case, or wrapped up so that usual operating temperatures are reached. Use signal tracing and substitution as needed to find the difficult troubles.

Handy Calculators for Sound Men

The two new calculators which have just been introduced save a great deal of time and effort in figuring the values for attenuator pads used in amplifier and speaker circuits, and in computing circuit constants for frequency equalizers and suppressors. The slide rule type calculators have circuit diagrams

printed on each side for pads, equalizers, and suppressors, with windows cut out of the outer case near the circuit constants. As the proper DB loss or resonant frequency is selected on the slide, the values of the resistors, condensers, and inductances appear in the windows near their schematic.

The Padget, as the attenuator pad

calculator is called, figures the resistor values for T, bridged T, pi, balanced pi, and grid potentiometer pads for 500/500 ohm circuits, 500/250, 500/125, 500/200, and 500/50 ohm matches, for DB losses from 1 to 60. Voltage and power in 500 ohms is also tabulated for the DB scale.

The Quadget, or equalizer and sup-

(Continued on page 58)



Philadelphia Radio Serviceman's Association broadcast over WFIL featured Thomas F. Joyce, RCA v.p. (third from left) and RCA engineers (left to right), Dr. G. A. Morton, electronics, G. L. Beers, television, Dr. H. F. Olson, acoustics.

Manufacturers

Why Not Have the LATEST and BEST!

WEBSTER-CHICAGO'S New Manual Recorder with Playback

- Double Rim Drive Motor
- Patented Noiseless, Powerful, Constant Speed Motor
- Webster-Chicago Famous Pickup in 1 Oz., 2 Oz. and 3 Oz. Types
- Patented Friction Drive Recording Arm with Choice of Crystal or Magnetic Cutting Head



DELUXE RECORD CHANGER

Exclusive principles with a minimum of working parts. Will play sixteen intermixed 10 and 12 inch records.



POPULAR STANDARD RECORD CHANGER

Featuring jam-proof mechanism with noise-free operation. Plays ten 12 inch or twelve 10 inch records.

Write or Wire Today for Details, Address Section O-8

5622 Bloomingdale Ave.
Chicago, Illinois

WEBSTER-CHICAGO

CORPORATION

"The Sound of Tomorrow"

Stands Out

BECAUSE IT STANDS UP!

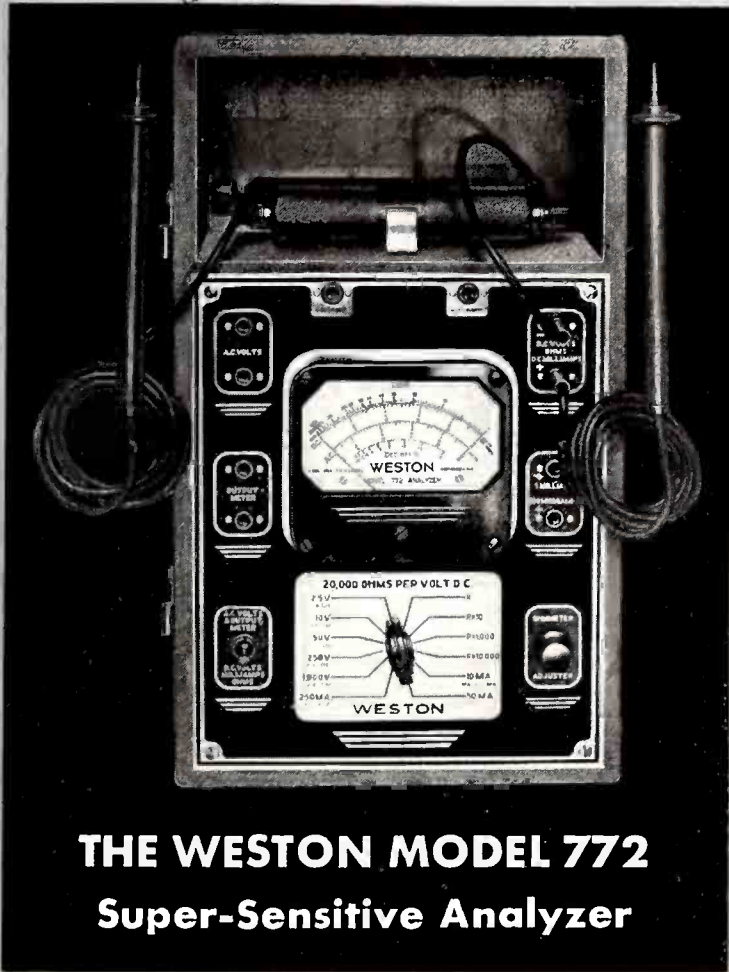

**THE WESTON MODEL 772
Super-Sensitive Analyzer**

Good service is a vital part of a strong industry. » » » The amazing growth of radio over twenty years reflects in no small part the essential job *you* do that keeps receiving sets tuned in on the networks of the globe.

To help you give this better service WESTON first introduced Model 772 in 1936. This *same model* is still tops! It stands out because it stands up — and you know how that helps *your profit*.

Model 772 is another of WESTON'S leading contributions to your important part in celebrating radio's twentieth anniversary. Once you team up with this foremost instrument you have a partner that will stick by you, always be a swell performer, and make good money for you for many years.

Consistently high quality in design and manufacture has maintained WESTON leadership for more than fifty years. All WESTON products stand out because they stand up! When you buy such dependable equipment you save and profit more. Make your next move with WESTON and you'll be right! Write for complete literature on Model 772 and other WESTON instruments for radio servicing. Weston Electrical Instrument Corporation, 597 Frelinghuysen Avenue, Newark, N. J.

RADIO'S *20th* ANNIVERSARY

WESTON is proud to salute the Radio Industry on its twentieth anniversary. There is no finer contribution to the advancement of mankind than that of all of radio's forces uniting to achieve this wonder: *with the speed of light the voice and music of man reach even the remotest corners of the world.*

Laboratory Standards . . . Precision DC and AC Portables . . . Instrument Transformers . . . Sensitive Relays . . . DC, AC, and Thermo Switchboard and Panel Instruments.

WESTON

Specialized Test Equipment . . . Light Measurement and Control Devices . . . Exposure Meters . . . Aircraft Instruments . . . Electric Tachometers . . . Dial Thermometers.

FOR OVER 52 YEARS LEADERS IN ELECTRICAL MEASURING INSTRUMENTS

If you recognize the finer things in instruments—

THE word "quality", is used more in advertisements than any other . . . and yet we all know that the place to look for it is not in advertisements, but in PRODUCTS!

You who have used testing instruments for a number of years recognize quality—or the absence of it—the moment you get your eyes and hands on testing instruments. Indeed Simpson Testers owe their meteoric rise to the fact that so many service men DO recognize the FINER THINGS in instruments.

If you know testing equipment you owe it to yourself to inspect Simpson instruments like those briefly described here. That is all we ask. The rest we leave to the instruments!



MODEL 400—Never before have so many features been combined in a tester. "Unit design" guards against obsolescence; visual guide ties in speed-roll chart with switches; three-way switching broadens scope. Your name engraved free on panel. Dealers \$36.00 net price



MODEL 240—A remarkable value in a pocket size (5 1/4 x 2 7/8 x 1 3/4") 3,000 volt, self-contained tester. Four A.C. and five D.C. voltage ranges at 1,000 ohms per volt; 0.15—150—750—milliamps; 0.3000—300.000 ohms. Dealers \$14.75 net price

A handsome new catalog covers the advanced Simpson line. Ask for your copy.

SIMPSON ELECTRIC CO.

5216-18 Kinzie St., Chicago, Ill



MODEL 300—A handsome, precision tube tester at a remarkable price. Filament voltages of .5 to 120 V. Tests local, single ended tubes, bantams, midjets, miniatures, ballast tubes, gaseous rectifiers, Christmas tree bulbs, etc. Has neon short check; "good" and "bad" markings; percentage scale; tube charts in cover. Dealers \$26.50 net price



MODEL 260—The outstanding value in a high sensitivity set tester for television and general servicing. Ranges to 5000 volts—both A.C. and D.C. at 20,000 ohms per volt D.C. and 1000 ohms per volt A.C. Resistance readings from 10 meg ohms down to 1/2 ohm and five Decibel ranges from -10 to +52 D.B. Dealers \$27.50 net price



MODEL 320—Giant tester with 9-inch illuminated meter. Has 50 ranges . . . nine A.C. and nine D.C. voltage ranges; six milliamperage ranges; five resistance ranges; four capacity ranges; seven decibel ranges. Entirely A.C. operated. All voltage ranges have resistance of 1,000 ohms per volt. Test leads included. Rack mountings available. Dealers \$37.50 net price

SIMPSON INSTRUMENTS THAT Stay ACCURATE

TOTAL DEFENSE!

You enjoy complete protection from competition in Sound sales with Clarion's 5-point Profit Plan. Find out what this means to you. Act at once.

Wire or write for Clarion preparedness set-up for increased P.A. sales and profits.

Clarion PUBLIC ADDRESS *Equipment*
TRANSFORMER CORP. OF AMERICA • 69 WOOSTER ST., NEW YORK

SERVICE NOTES

(Continued from page 56)

pressor calculator, gives the inductance, resistance, and capacitance values for resonant frequencies from 60 to 10,000 cycles and for three response curves, sharp, medium and broad. This calculator will conveniently handle the design of networks for use as scratch filters, heterodyne suppressors, or response equalizers.

These two calculators were designed by C. G. McProud and are available through Norman B. Neely Co., 5334 Hollywood Blvd., Hollywood, Calif. The Padget is priced at \$1.25, while the Quadget is \$1.50.

Typical Troubles

Atwater Kent 55

Set dead. Check for open cathode resistor of '27 AF stage. Replace with one watt, 3000 ohms.

Automatic P57

Set plays short time, then oscillates or goes dead. Add 0.1 mfd. bypass from screen of 1N5-GT to chassis.

Emerson DM331

Set operated on short wave range but not on broadcast band. Trouble is open oscillator grid coil for BC range. This coil is in series with the short wave section.

General Electric G-106

Pushbutton tuning motor operates in both directions, clockwise and counter clockwise, but dial pointer moves only toward 550 kc. end. Loosen set screws of rubber friction bushing on motor shaft and allow it to press more firmly on drive wheel. Also check contacts at rear of tuning condenser. Clean them and selector rim with carbon tetrachloride.

Halsen 05

Intermittent. Check for loose ground on RF stage coil. If mounting bracket is loose drill out rivet and use bolt to hold it. Solder wire to bracket and to ground for good connection.

RCA K80, U42, 19K

Rattle on bass notes. Check loops for solid and secure mounting to cabinet.

Communication Over Light Beams

O. T. McIlvaine, chief engineer of Continental Electric Co., Geneva, Ill., suggests that for communication on large farms and ranches, and between other widely separated buildings, light beams be used, rather than radio.

"For example, on a good-sized ranch it may be several miles from one building to the other and it would be advantageous to be able to communicate without the necessity of running wires. By radio the transmission would not be confidential, whereas by means of the photo electric light-beam communication would be strictly private. Photo-beam communication would not

require a licensed transmitter as would be the case with short-wave radio.

"Photo-cell devices are very little more expensive than an average radio set, and consist merely of a radio amplifier with a gas-filled lamp of the proper type, in place of the loud-speaker, so that when the microphone is spoken into, the brilliance of the lamp varies in accordance with the voice frequency. By means of a simple telescope this lamp is then focused on a similar lens system at the receiving end where a photo cell is behind the lens and connected to the input of an amplifier.

"By means of a switch arrangement the same amplifier can be used for the receiver and the transmitter, the loud-speaker being cut into the output circuit for the receiver and the transmitting lamp being cut into the output circuit for the transmitter."

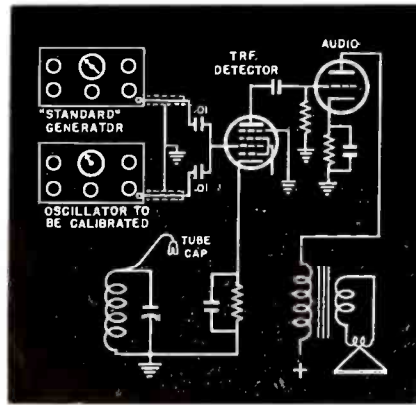

resistor is not shown. Set the oscillator to be checked at some dial division easily read, and tune the "stand-ard" generator until a beat-note is heard in the speaker. Tune to zero beat and note dial reading on stand-ard. The oscillator outputs will have to be quite high on the high frequency bands.

It may be easier to leave the stand-ard generator set to a frequency and tune the other oscillator until the beat-note is heard if the dial calibrations are easier to read on the job to be checked.

Graphs may be plotted or the neces-sary adjustments made to correct any discrepancies.

RCA Tube Preference List Reduced to 31

The RCA Preferred-Type Tube Program passed its first anniversary this month with the announcement that the number of receiving-tube types it covers has been reduced from 36 to 31, and that two other types have been replaced to coincide with today's receiver-design trends. L. W. Teegarden, manager, listed a total of 19 radio set manufacturers who have adopted the plan.

Three types, 1G4G, 1G6G and 6N7G, have been eliminated from the preference list as the result of a swing away from type B audio systems. Type 2A3 is becoming less and less popular with engineers, and has also been dropped. Increased volume of orders for the 6J5 has made possible manufacturing economies to bring its cost into competition with the 6J5GT, which has been deleted from the list.

Two changes of types on the list were caused by a growing tendency in the AC-DC set field for seven and eight-tube receivers. The tube complement for such a receiver, if drawn from 150 milliamper tubes on the preference list, adds up to a greater heater voltage than the normal line voltage. So 6.3 volt 300 milliamper tubes must be substituted, although there have been no power output and rectifier types on the preference list useful for this purpose. Thus it is that types 25L6GT and 25Z6GT have been substituted on the list for types 12SJ7 and 12C8.

Re-calibrating Signal Generators

It is sometimes necessary to check the calibration of a signal generator when there is reason to believe it is off, or that age has caused it to drift slightly. If you have or can borrow an oscillator which is sufficiently accurate for all purposes, connect it with the generator to be checked as shown in the diagram. Use a TRF receiver as the beat-note indicator. Remove the grid cap from the detector and feed both signals in through the coupling condensers. It will be necessary to connect a 1 meg resistor from the grid terminal to ground, although the

MODEL TR321-A . . . 7-Tube*
Recorder—Radio-phonograph-recorder-public address system. Self-starting motor—crystal pick-up—tone control—mixing control. Built-in antenna. Cabinet: Hand-rubbed select walnut. 20" wide, 12 3/4" high, 14" deep. \$79.95

MODEL T101L-A . . . 5-Tube*
AC-DC—Standard broadcast and Police. 5" P.M. Dynamic speaker. Self-contained line cord antenna. Automatic volume control. Cabinet: Hand-rubbed select walnut. 13 3/4" wide, 7 1/2" high, 6" deep. \$17.95

MODEL T202-A . . . 6-Tube*
AC-DC—American-Foreign-Police broadcasts. 6 1/2" P.M. heavy duty Dynamic speaker. Tone control. Automatic volume control. Built-in antenna. Cabinet: Hand-rubbed select walnut. 17 1/2" wide, 9" high, 7 1/2" deep. \$29.95
* Including Rectifier

**OFFERS AGGRESSIVE DEALERS
6 NEW 1941 MAJESTIC
HOLIDAY SEASON SPECIALS**

- This year let's ring up profits—not just sales. The best 6 weeks of the year are ahead—the right time to feature these 6 new Majestic Christmas specials. Easy to sell—profit merchandise. Write for details today.

MAJESTIC is completely reorganized and strong financially. The management is fully experienced, and the operation of the company is being carried forward on a sound, conservative basis.

The tremendous acceptance given MAJESTIC by the buying public offers aggressive radio jobbers and dealers the opportunity to capitalize on an established name.

**JOBBER-DEALERS . . . write today
for catalog and complete information
on MAJESTIC for 1941.**

**MAJESTIC RADIO AND TELEVISION CORP.
2600 WEST 50TH STREET • CHICAGO, ILLINOIS**

Sickles coil kit

★ Kit with all necessary material (except wire) to make any type of coil used in radio receivers. Included in it are terminal brackets, eyelets, spade lugs, washers, screw studs, bakelite terminal plates, sticker tape, varnished cambric, wood dowels, and large assortment of partly assembled punched and plain bakelite and paper forms in various lengths and diameters. F. W. Sickles Co., 165 Front St., Chicopee, Mass.—**RADIO TODAY.**

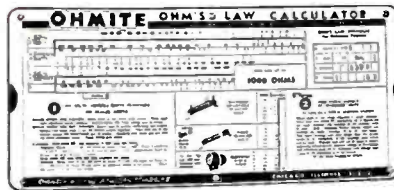

Ohmite calculator

★ A convenient calculator gives the answer to any Ohm's law problem quickly, with one setting of the slide. Covers range of currents, resistances, wattages, and voltages used in both radio and commercial work. Also lists hundreds of stock values. May be obtained from Ohmite Mfg. Co., 4835 Flournoy St., Chicago, Ill., for 10c. in coin.—**RADIO TODAY.**

NEW

Micamold dry electrolytics

★ Complete line of type MP dry electrolytics available in sufficient capacity and voltage ranges for practically all replacement requirements. Standard lug mountings with both 3 and 4 terminals, 1 in. and 1 3/8 in. diameters. Micamold Radio Corp., Flushing and Porter Aves., Brooklyn, N. Y.—**RADIO TODAY.**

WHERE TO LOOK FOR NEW SALES AND BIGGER PROFITS!



CARILLONS • MUSICAL TOWERS

New Big Profit Outlet—Live wire sound men can cash in on the big demand for tower and bell chimes. Sunco Carillons are sold and installed by qualified dealers exclusively. Sales Leads! We advertise regularly in 10 leading church publications that cover an audience far in excess of one quarter million readers. These exclusive features mean more profits—easier, quicker sales: Micro-tuning to 1/5000 of 1% permits playing of any harmony, same as on a piano. Speakers handle deepest tones at full power. Covers area 2 miles in diameter. Many special carillon records available. **READ THIS:** If you have an established sound business with commercial listing, and are looking for a new profit outlet—Write us at once!

SUNDT ENGINEERING COMPANY
4763 Ravenswood Ave., Chicago, Illinois

Sell & Use LITTELFUSES

WRITE FOR CATALOG

Get this new catalog free. Shows complete line of Littelfuses for radio, transmitters, rectifiers, meters, instruments. FUSE MOUNTINGS—all kinds. **FUSE MOUNTINGS—LITTELFUSE!** See your jobber or write:

LITTELFUSE INC.
4763 RAVENSWOOD AVE. CHICAGO, ILL.



Hickok oscilloscope

★ Model RFO-5 has self-contained wide band FM oscillator and narrow band oscillator for AM receivers. Demodulator, video amplifiers, signal tracer, AC vacuum tube voltmeter 0.2 to 1,000 v. FM oscillator can be modulated from external sources with phono pickup or mike to provide FM transmitter for laboratory checks. Hickok Elec'l Instr. Co., 10305 Dupont Ave., Cleveland, Ohio.—**RADIO TODAY.**

Burton auto antenna

★ Four section longer antenna for replacement use on Ford and Buick cars extends to 57 inches and telescopes to 17. Easy installation. Model 357, price, \$1.95. Burton-Rogers Co., 857 Boylston St., Boston, Mass.—**RADIO TODAY.**



RCA VoltOhmyst Jr.

★ This test meter incorporates the Rider VoltOhmyst circuit. Input resistance 11 megohms. DC voltmeter ranges 0 to 3, 10, 30, 100, 300 and 1,000 v. Ohm ranges to 1,000 megohms. AC voltage, 0 to 10, 30, 100, 300 and 1,000; sensitivity, 1,000 ohms per volt. \$34.95. RCA Mfg. Co., Camden, N. J.—**RADIO TODAY.**

Philco inter-communicator

★ Philcophone 2-way inter-room communicator system. Master control unit complete with 1 remote control station and 50 ft. of 3-wire cable sells for \$29.95. Additional remote control stations (master control will operate 5) sell for \$7.50 each including wire. Philco Radio & Telev. Corp., Tioga & C Sts., Phila., Pa.—**RADIO TODAY.**

POWER TO SPARE

BIG SET TONE

A STYLE CREATION

ONLY 4 1/2 LBS.

ONLY \$19.95 LIST WITH BATTERIES

OVERNIGHT SENSATION!

SENTINEL'S NEW "Lightweight Champion"

Talk about a "natural" for big-volume, big-profit Holiday sales—this is it! Sentinel's sensational new, compact, camera-type, portable radio that has taken the country by storm. Show it, push it, sell it—use this "Lightweight Champion" to pull more prospects to your store. Write now for full information on this and the other Sentinel super-values—electric and battery sets, new portables, combinations and new home recorders.

SENTINEL RADIO CORPORATION
2020 Ridge Ave., Dept. RT-11 Evanston, Ill.

IT'S NEW!
BE FIRST TO SHOW THIS NEWEST RADIO MIRACLE
It's Different!

Sentinel

Quality Radio Since 1920

EQUIPMENT

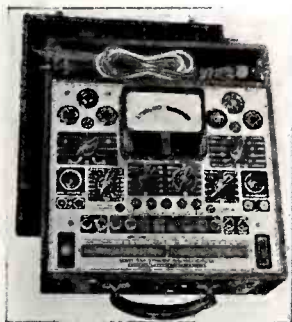

Precision tester 954

★ Combination mutual conductance type tube tester and 37 range AC-DC set tester. 20,000 ohms per volt, ranges of 6,000 v. AC-DC, 60 microamperes, 12 amps, 60 megohms. 5 models, open, counter, standard panel and hardwood portable type. Precision Apparatus Co., 647 Kent Ave., Brooklyn, N. Y.—RADIO TODAY.

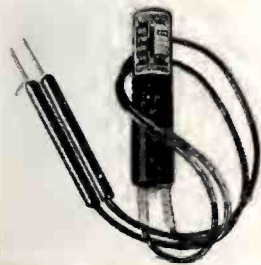

Square D voltage tester

★ No. 5000 tester indicates voltage by position of pointer in relation to graduated scale. Different colored bands used for each AC voltage, 110, 220, 440, 550. AC distinguished from DC by vibration of the pointer. Long, rubber covered lead wires are fitted with hooks and sharp points for piercing wire insulation without damage. Square D Co., Detroit, Mich.—RADIO TODAY.

Miles Filmgraph

★ Filmgraph is device for recording and reproducing sound on film electro-mechanically. Model ADB is entirely automatic. Housed in walnut case with removable front and back covers. Loudspeaker mounted on back cover, lever control for recording, play-back, neutral and re-wind on front cover. Accommodates 500 ft. of film with 40 sound tracks across width of film. Miles Reproducer Co., Inc., 812 Broadway, N. Y. C.—RADIO TODAY.



Solar capacitors

★ Type DO, new series dry electrolytic capacitors in metal cans, plug-in type to fit standard octal tube base sockets. Straps are available. Usual ratings can be furnished including multiple units. Solar Mfg. Corp., Bayonne, N. J.—RADIO TODAY.

RCA 117 v. tube

★ New type tube for AC/DC battery use is 117N7-GT half-wave rectifier and beam power amplifier. The amplifier will deliver 1.2 watts with 100 volts on the plate. Grid bias is -6, plate current 51 mills, zero signal. RCA Mfg. Co., Harrison, N. J.—RADIO TODAY.



Dorothy Claire, vocalist with Bobby Byrne's orchestra, is shown with the new Electro-Voice Cardak, 726, a poly-directional mike.

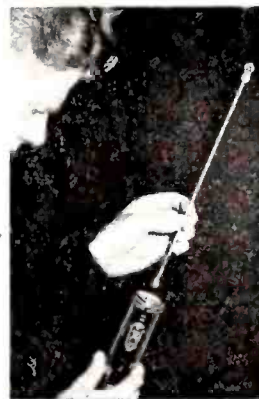

Flashlight bulb extension

★ Sierra flashlight bulb extension—a closely spotted light for hard-to-get-at places is made in lengths from 6 in. to 36 in. Has plug which screws into any flashlight. Special wire encased in aluminum alloy tubing. Bendable, can be made into hook shape or fashioned into its own stand. Sierra Aircraft Co., Sierra Madre, Calif.—RADIO TODAY.

MAGNAVOX

- Founded in 1911, Magnavox has contributed much to the development of the radio industry. Inventors and manufacturers of the first loud speaker, the electro-dynamic speaker, first single dial radio set, first public address system, first amplified phonograph, and the first amplified radio-phonograph combination.
- Since the very inception of radio, Magnavox has been the internationally famous loud speaker.

These many years of experience and achievement are reflected in the outstanding tone quality and the matchless performance of every individual Magnavox instrument!

The Oldest Name in Radio.

THE MAGNAVOX COMPANY, INCORPORATED, FORT WAYNE, INDIANA, U. S. A.

Stickers coil kit

* Kit with all necessary material (except wire) to make any type of coil used in radio receivers. Included in it are terminal breakers, eyelets, spade lugs, washers, screw studs, bakelite terminal plates, stickers, tape, varnished cambric, wood dowels, and large assortment of partly assembled punched and plain bakelite and paper forms in various lengths and diameters. F. W. Stickers Co., 165 Front St., Chicopee, Mass.—**RADIO TODAY.**



Ohmite calculator

* A convenient calculator gives the answer in any Ohm's law problem quickly with one setting of the slide. Covers range of currents, resistances, wattages, and voltages used in both radio and commercial work. Also lists hundreds of stock values. May be obtained from Ohmite Mfg. Co., 4835 Flournoy St., Chicago, Ill., for 10c. in coll.—**RADIO TODAY.**

WHERE TO LOOK FOR NEW SALES AND BIGGER PROFITS!



CARILLONS • MUSICAL TOWERS

New Big Profit Carillon—like wire music men can cash in on every big demand for fancy and better quality organs. Carillons are sold and installed by qualified dealers exclusively. Sales limited. We advertise regularly in 10 leading church publications that cover an audience far in excess of one quarter million readers.

These exclusive features make more profits—easier, faster sales: Micro-tuning to 1/10000 of 1% permits playing of any harmony, even on a piano. Microtones in diameter. Many special carillon records available. **IRKAD TONE:** If you have an unutilized sound installation with commercial listing, you are looking for a new profit outlet—write us at once!

SUNDT ENGINEERING COMPANY

4743 Ravenswood Ave., Chicago, Illinois

Sell & the LITTELFUSES

WRITE FOR CATALOG

Get this new catalog free. Shows complete line of Littelfuses for radio, television, testsets, meters, instruments. **PLUS MONEY!** IN—on all kinds. When you want more—**LITTELFUSES** Inc. your jobber or wholesaler.

LITTELFUSE INC.
4703 RAVENSWOOD AVE. CHICAGO ILL.

POWER TO SPARE
BIG SET TONE
A STYLE CREATION

ONLY 4 1/2 LBS.
ONLY \$19.95
LIST WITH BATTERIES

OVERNIGHT SENSATION!
SENTINEL'S NEW "Lightweight Champion"

Talk about a "natural" for big volume, big profit Holiday sales—the all-Sentinel's renowned new, compact, semi-compact, portable radio has taken the country by storm. Show it, push it, sell it, use the Lightweight Champion. In bulk more prospects to your store. Write now for full information on this one of the silver Sentinels—valuable, electric and battery sets, new speakers, combinations and new home sets.

SENTINEL RADIO CORPORATION
2600 Ridge Ave., Dept. RT-31 Evanston, Ill.

IT'S NEW!
BE FIRST TO SHOW THIS NEWEST RADIO MIRACLE! It's Different!

Quality Radio Since 1920

NEW EQUIPMENT

Micomold dry electrolytics

* Complete line of type MF dry electrolytics available in sufficient capacity and voltage ranges for practically all replacement requirements. Standard lug mountings with both 3 and 4 terminals, 1 in. and 1 1/2 in. diameters. Micomold Radio Corp., Flushing and Porter Aves., Brooklyn, N. Y.—**RADIO TODAY.**



Precision tester 954

* Combination mutual conductance type tube tester and 37 range AC-DC set tester. 20,000 ohms per volt, ranges of 6,000 v. AC-DC, 60 microamperes, 12 amps, 60 meg-ohms. 5 models, open, counter-standard panel and hardware portable type. Precision Apparatus Co., 617 Kent Ave., Brooklyn, N. Y.—**RADIO TODAY.**



Hickok oscilloscope

* Model HFO-5 has self-contained wide band FM oscillator and narrow band oscillator for AM receiver. Demodulator, video amplifier, signal tracer, AC vacuum tube voltmeter 0.2 to 1,000 v. FM oscillator can be modulated from external sources with phono pickup or mike to provide FM transmitter for laboratory checks. Hickok Elec'l Instr. Co., 10305 Dupont Ave., Cleveland, Ohio.—**RADIO TODAY.**



RCA VoltOhmyst Jr.

* This test meter incorporates the Rider VoltOhmyst circuit. Input resistance 11 meg. DC voltmeter ranges 0 to 3, 10, 30, 100, 300 and 1,000 v. Ohm ranges to 1,000 meg. AC voltage 0 to 10, 30, 100, 300 and 1,000; sensitivity, 1,000 ohms per volt. RCA Mfg. Co., Camden, N. J.—**RADIO TODAY.**

Philco inter-communicator

* Philcophone 2-way inter-room communicator system. Master control unit complete with 1 remote control station and 60 ft. of 3-wire cable sets for \$29.95. Additional remote control stations (master control will operate 6) sell for \$7.50 each including wire. Philco Radio & Telev. Corp., Ticon & C Sts., Philadelphia.—**RADIO TODAY.**

Burton auto antenna

* Front section longer antenna for replacement use on Ford and Hupok cars extends to 67 inches and telescopes to 17. Easy installation. Model 357, price, \$1.95. Burton-Hoggar Co., 457 Hoytston St., Boston, Mass.—**RADIO TODAY.**

Miles Filmgraph

* Filmgraph is device for recording and reproducing sound on film—electron-mechanically. Model ADB is entirely automatic. Housed in walnut case with removable front and back covers. Loudspeaker mounted on back cover, lever control for recording, play-back, neutral and rewind on front cover. Accumulates 500 ft. of film with 40 sound tracks across width of film. Miles Reproducing Co., Inc., 812 Broadway, N. Y. C.—**RADIO TODAY.**



Dorothy Claire, vocalist with Bobby Byrne's orchestra, is shown with the new Electro-Voice Cardak, 726, a poly-directional mike.

Solar capacitors

* Type DO, new series dry electrolytic capacitors in metal cans, plug-in type to fit standard octal tube base sockets. Straps are available. Usual ratings can be furnished including multiple units. Solar Mfg. Corp., Bayonne, N. J.—**RADIO TODAY.**



Square D voltage tester

* No. 5000 tester indicates voltage by position of pointer in relation to graduated scale. Different colored bands used for each AC voltage, 110, 220, 440, 550. AC distinguished from DC by vibration of the pointer. Long, rubber covered lead wires are fitted with hooks and sharp points for piercing wire insulation without damage. Square D Co., Detroit, Mich.—**RADIO TODAY.**

RCA 117 v. tube

* New type tube for AC/DC battery use is 11N7-GT half-wave rectifier and beam power amplifier. The amplifier will deliver 1.2 watts with 100 volts on the plate. Grid bias is —6, plate current 61 mills, zero signal. RCA Mfg. Co., Harrison, N. J.—**RADIO TODAY.**

Flashlight bulb extension

* Sierra flashlight bulb extension—a closely spotted light for hard-to-get places is made in lengths from 6 in. to 36 in. Housing which screws into any flashlight. Special wire encased in aluminum alloy tubing. Inexpensive, can be made into hook shape or fashioned into its own stand. Sierra Mfg. Co., Sierra Madre, California.—**RADIO TODAY.**

MAGNAVOX

- Founded in 1911, Magnavox has contributed most to the development of the radio industry. Inventors and manufacturers of the first loud speaker, the electro-dynamic speaker, first single dial radio set, first public address system, first amplified phonograph, and the first amplified radio-phonograph combination.
- Since the very inception of radio, Magnavox has been the internationally famous loud speaker.

These many years of experience and achievement are reflected in the unsurpassing tone quality and the unshakable performance of every individual Magnavox instrument!

The Oldest Name in Radio

THE MAGNAVOX COMPANY, INCORPORATED, FORT WAYNE, INDIANA, U. S. A.

YOU CAN SELL MORE RADIO SETS THIS YEAR —if you follow these 6 rules

1 Give a good demonstration of the new home recording feature. It's the quickest way to convince your customer that he ought to have a new set.

2 To make good demonstrations give each of your salesmen a Presto STELLITE cutting needle for his own exclusive use. It will assure him of 100 or more perfect demonstrations at a fraction of a cent each.

3 Use only PRESTO BLUE LABEL DISCS for demonstrating recording. It isn't worth while to save a few cents on the demonstration disc and take a chance of killing a \$150.00 sale.



4 Sell each customer a PRESTO HOME RECORDING KIT with his set. Start him off right. It will save you free service calls. It will help him make good recordings from the beginning... make him a regular disc customer.

5 Use the PRESTO COUNTER DISPLAY. Show your customers you carry the highest quality discs and needles. Everyone who comes into your store this Fall is a probable buyer.



6 Use the Presto window and wall posters, advertising mats, direct mail order cards. They'll bring you new customers, more business.

JOBBERS—write today for full information on Presto recording accessories—price sheets for your salesmen's folders, free broadsides to mail to your dealers, free merchandising aids for your dealers.

PRESTO RECORDING CORPORATION

242 W. 55th St., New York, N. Y.

World's Largest Manufacturers of Instantaneous Sound Recording Equipment

DISTRIBUTOR DOINGS



Sound men at the Seattle Radio Supply Co., Seattle, Wash. Left to right, H. L. Shortt, president, TCA, who stopped here during nation-wide tour; Bert Harris and Ed Mickelson, Seattle Radio; and R. C. James, Jr., Northwestern representative for Clarion.

Sound Sales on the Upgrade

"The sound industry as a whole should expect a very good season," is the observation of H. L. Shortt, president of Transformer Corp. of America, (makers of Clarion P.A.

equipment) after he had completed a 9,000-mile sales tour over the entire U. S. The TCA exec also found good acceptance for his product, and reports "a great upswing in Clarion sales for the year."

From many visits to jobbers and sound men, Mr. Shortt gained first-hand knowledge on the progress of

It's Selling Big!
THE NATIONAL REGENAFORMER

This new type of Radio Frequency Transformer has proved so efficient that 90% of the value of amplification calculated by mathematics in laboratory tests is obtained actually in practice—which is more than 3 times the amplification value produced by the usual type of tuned R F transformers. It is incorporated in the Bronning Drake circuit, which has essentially 2 sub-detector and radio amplifier—to which 2 stages of audio may be added.

Price of kit for set illustrated \$22.00
The National Regenafomer and Coil only, price 7.50

We are ready to extend distribution

New dealers can now take it on and be assured of responsible deliveries. It is a real proposition. No exaggerated statements are needed to sell it—either in our advertising to you, or on your part in your trade.

Write for literature and discounts, but do it quickly. We will not take on more dealers than can be guaranteed quick service. Write now.

THIS is the National "Velvet Vernier" Condenser and Dial—the most distinctive condenser of all. Electrically and mechanically it is the finest that scientific principle and painstaking skill can commercially produce. This has been amply proved by its success in sets operated on wave lengths of 15 meters. The velvet smooth vernier gives perfect reduction over the entire range. No backlash whatever. Made in four sizes. Write for Folder and Prices

NATIONAL CO., Inc., Cambridge, Mass.
Engineers and Manufacturers
Established 1914

Back in 1925

Back in 1925 this ad appeared in radio trade papers. Many of the manufacturers who advertised in those early years have since fallen by the wayside, but with National even products have survived. The Velvet Vernier Dial shown above is still a best seller, and the DX Condenser is still being built into commercial and industrial equipment. This long life is an extraordinary tribute to the advanced design and fine craftsmanship that have always been a National tradition.



NATIONAL COMPANY, INC., MALDEN, MASS.

Clarion products, and returned to TCA headquarters at 69 Wooster St., New York City, with a very optimistic view.

NRPDA in New Series of Sectional Meets

The latest meeting for members of the National Radio Parts Distributors Association was staged Nov. 3 at Springfield, Mass., at the Hotel Kimball, with a crowd of jobbers of the area on hand for a new discussion of distribution problems and trends. NRPDA is expanding its organization activities and meetings are now being held in increased numbers.

The Springfield session followed an earlier meeting held last month in Pittsburgh, Pa., when jobbers from Ohio, Pennsylvania and W. Virginia got together for a lively discussion. The group was addressed by Arthur Moss, NRPDA executive secretary, 65 Park Terrace East, New York City, and among the guests was George D. Barbey, president of NRPDA.

This month, NRPDA is planning a series of sectional meetings in Chicago, Detroit, Minneapolis, and Kansas City, all events of special interest to distributors in those areas.

Radiola Line for Parts Jobbers

The new series of Radiola table models, designed by RCA especially for the radio service dealer, is now being presented to parts jobbers and servicemen throughout the country. Shows are being staged by John C. Marden, RCA's manager of Radiola sales, in key cities, where parts distributors and their whole organizations are invited to attend meetings.

The Radiolas include six AC-DC table models in the \$9.95 to \$19.95 price range, a battery AC-DC portable, and a record player attachment; some are shown on earlier pages of this issue. Some 80 parts jobbers are already handling the sets.

Mr. Marden's presentations include an outline of the special Radiola tie-in with parts jobbers activities, complete sales helps, advertising and promotion of the new sets. It is explained how Radiolas give tube and equipment jobbers handling RCA products "a short line . . . with high initial investment cut down . . . to broaden distributors' activities with their customers."

Jones Shows Oscillator Applications

The latest lecture given for radio servicemen by Walter R. Jones, director of commercial engineering for Hygrade Sylvania Corp., was "Oscillators and Their Applications" delivered for a large group of technicians in Wilkes-Barre, Pa. Mr. Jones was assisted by George Isham, Sylvania sales rep in New York and Pennsylvania.

This meeting was sponsored by the Lucerne County Radio Servicemen's Association. Others have recently been conducted by Mr. Jones in Wichita, Kan. Kansas City, Mo.; and Des Moines, Ia.

Crosley Adds to N.Y. Staff

A number of additions to the personnel of the Crosley Distributing Corp., New York, have been announced by general manager Fielding Robinson.

Tom Boyne, formerly with Crosley and more recently with Kelvinator has been made sales manager of the refrigeration division. Sam Present has been appointed sales manager of the home laundry and range division. Mr. Present was formerly with Emerson and the National Light & Electric Co. F. W. Paul has been named sales promotion manager. He was formerly with the Westinghouse Electric & Mfg.

Co. in N. Y., Albany and Reading in promotional activities.

Excitement for NU Jobber in London

A report received by National Union Radio Corp. from the company's distributor in London gives a graphic account of the bombs falling around the establishment. In the account the jobber says that . . . "the other night we got a severe shaking, as a nasty aerial torpedo was dropped a little too close . . . we heard it falling and dived for cover . . . but you can rest assured that Hitler will never demoralize the people of England by bombing from the air . . ."

CLEVELAND NEWS "Elected" San Francisco News
The Boston Daily Globe Chicago Herald Tribune
St. Louis New York World Telegram

SERVICING by SIGNAL SUBSTITUTION

Returns from radio service engineers, everywhere, ACCLAIM this new, simplified method of Dynamic Receiver Analysis which requires NO EXTRANEIOUS APPARATUS . . . NOTHING COMPLEX TO LEARN . . .

Every necessary facility for modern servicing (A.M. and F.M.) is provided by an economical selection of only 3 BASIC test instruments . . . The Signal Generator (such as PRECISION Series E-200), The Dynamic Mutual Conductance Type Tube Tester (such as PRECISION Series 910), and the Super Sensitive Multi-Range Set Tester (such as PRECISION Series 854).



• FREE •

A 120 page text book "Servicing by Signal Substitution" describes this simplified approach to receiver adjustment problems. Available at leading distributors or directly from factory at 35c — Write for it today! Also furnished FREE with every Precision Series E-200.



Series 910 — Dynamic Mutual Conductance Type Tube Tester

• The first step in "S-S-S" is the rapid, unflinching elimination of defective tubes. PRECISION Dynamic Mutual Conductance Type Tube Testers permanently and efficiently remove the "Question Mark" from your tube test problems.

910MCP—in dull black wrinkle finished, open face metal cabinet as shown for Series E-200 . . . \$29.95

910P—(illustrated)—in hardwood walnut finished portable case. Also available in counter or standard panel mount. . . \$33.95

Series E-200 — Modern Laboratory Type Multi-Band Signal Generator

• Not only an unsurpassed Signal Generator for purposes of receiver alignment, but SPECIFICALLY DESIGNED as the key to "Servicing by Signal Substitution" . . . Nevertheless priced within the easy reach of every progressive radio service engineer.

E-200—(illustrated)—in heavy gauge metal cabinet, complete with tubes, coaxial output cable and FREE copy of "Servicing by Signal Substitution" . . . \$35.95

E-200PM—in standard panel mount. Complete . . . \$39.95

Series 854 37 range, rotary selective, super-sensitive set tester—20,000 ohms/volt D.C., 1000 ohms/volt A.C.—permits rapid check of voltage, current, resistance, etc., in troublesome stages, quickly localized through "Servicing by Signal Substitution." 6000 Volts—60 Microamps—60 Megs.—12 Amps. Series 854-L . . . \$37.95

• More than 40 models in the New PRECISION 1941 LINE . . . 21 Dynamic Mutual Conductance Type Tube Tester and Set Tester models ranging in price from as low as \$29.95 . . . 16 Multi-Range Tester models from as low as \$14.95 . . . Signal Generators from \$35.95 . . . See them at your local distributor . . . Ask or write for the PRECISION TEST EQUIPMENT 1941 CATALOG.

PRECISION TEST EQUIPMENT
Standard of Accuracy SEE THEM AT YOUR JOBBER

PRECISION APPARATUS COMPANY • 647 KENT AVENUE • BROOKLYN, N. Y.
Export Division: 458 Broadway, New York City, U.S.A. Cable Address: Morhanex



WHERE'S OUR RADIO!

I DON'T THINK YOU
KNOW HOW TO FIX IT!

WOW!
I WANT TO HEAR
THE LONE RANGER
WOW!

Cut Out the Panic From Your Work—

Stop having to apologize for delivery delays. Stop wasting hours in "guessing" the trouble in a set. **KNOW** with **RIDER MANUALS**. They provide the

only source, where you will find in one place, complete data on alignment, I-F peaks, operating voltages, parts lists and values, voltage ratings of condensers, wattage ratings of resistors, coil resistance data, gain data, and all the other essential information you need for trouble shooting on all receivers. There is a reason why every successful service shop is equipped with a complete set of **RIDER MANUALS!** Stop in at your jobber's today and get those volumes **YOU'VE** been intending to buy.

CHECK! Order Missing Volumes

Vol. Price	Covering	Vol. Price	Covering
XI \$10	Up to May 15, 1940	VI \$7.50	1935-36
X 10	1939-40	V 7.50	1934-35
IX 10	1938-39	IV 7.50	1933-34
VIII 10	1937-38	III 7.50	1932-33
VII 10	1936-37	II 7.50	1931-32
		I 7.50	1920-31

JOHN F. RIDER, Publisher, Inc.
404 FOURTH AVE. NEW YORK CITY

EXPORT DIVISION—Rocke-International Elec. Corp.
100 Varick Street, New York City Cable: ARLAB

You NEED RIDER MANUALS

IS 15% TO 20% OF YOUR TELEGRAPH BILL WASTE?

Postal Telegraph can tell you! Just by checking your communications files. This free survey produces *phenomenal* results for others. Provides easy-to-follow plan to end waste permanently.

WIRE COLLECT:

For Free Telegraph File-Analysis—With No Obligation to You—Wire Collect: P. B. Hinerfeld, Postal Telegraph, 253 Broadway, New York City.

Postal Telegraph

Raytheon Revises Tube Prices

A general price revision on replacement tubes, effective Nov. 4, has been announced by Raytheon Production Corp. The changes, practically speaking, amount to a weighted average increase of more than 5 per cent in prices, and the move is described as a constructive one because "it marks the first time in several years when it has been possible to institute a policy which has a proportionate relationship with the ultimate problems of tube distributors." It is pointed out that the revisions should help distributors with problems connected with rising costs of doing business.

The new prices were announced by Raytheon's manager of replacement sales, Earl S. Dietrich. In general, list prices and net prices have changed on 250 types; 139 types to higher levels, and 111 types to lower ones. Now, there will be 12 price brackets; formerly, 7 were in use.

Philco Accents 12-Month Profits

Philco has revealed that sales of their refrigerators for the 1940 season registered a spectacular gain of over 300 per cent. The company points out that such acceptance has meant extra profits to dealers at a time when radio sales were not in peak condition, so that "Philco All Year 'Round" is a reality. Plans for today's radio peaks were made while boxes had their seasonal rush; plans for new refrigerators are being made now, while radio sales are up.

Philco announces that a complete new line of refrigerators are now in production, with features that will give the dealer's 1941 franchise a new significance.

"Chet" Walker Goes to Utah



News from the Utah Radio Products Co., Chicago, is that the firm has a new assistant chief engineer—C. L. "Chet" Walker, a prominent engineer who was for many years with the United American Bosch Corp. The announcement was made by the Utah general sales manager, O. F. Jester.

Mr. Walker is welcomed to the Utah

organization by Chief engineer W. E. Ellmore, who points out that the long and successful experience of the new assistant in radio engineering and development work makes him particularly well fitted for his new duties.

Salesman Santa



This merry display comes from Majestic Radio & Tele. Corp., 2600 W. 50th St., Chicago. Just the thing for one console, or for 3 table models.

Adams Gets Sonora Post

From Sonora Radio & Television Corp., Chicago, comes the announcement by Ben Freund, vice-president in charge of factory operation, that Robert Adams has been named Works Manager for Sonora. Mr. Adams was formerly radio superintendent for Stewart-Warner; he also worked with GE, RCA, Atwater Kent and others during his long and varied radio experience both here and abroad.

Trio of Distribs for Admiral

Three jobbers among those recently named by Continental Radio Television Corp., 3800 Cortland St., Chicago, to handle Admiral radios are: Cavanaugh Co., 928 W. Royan, Youngstown, Ohio; Hyland Electric Co., 700 W. Jackson, Chicago; Hardware & Supply Co., 475 High St., Akron, Ohio.

West Virginia Dealers Hear of Stromberg-Carlson's FM

Some 200 salesmen at the Monongahela-West Penn Public Service Co., Fairmont, W. Va., heard radio sales manager Fred Anibal of Stromberg-Carlson explain his firm's position on FM at a meeting, where the 1941 line of Stromberg-Carlson's was presented.

Mr. Anibal said "there were more Stromberg-Carlson's which include the FM band, of more types, in more homes, than there are of any other make. Our complete line of FM radios and FM combinations is a seasoned line backed by more than a year of field experience," he declared. "No other radio manufacturer has had such long and varied experience in the making of instruments for the transmission and reception of sound."

A. H. Stroud, promotion manager of Monongahela-West Penn presided at the meeting. J. E. McCauley, SC district manager, and F. C. Rhodes, engineer, also attended.

Clarostat Names Indiana Engineer

I. J. (Jim) Youngblood is now sales engineer in the Indiana territory for Clarostat Mfg. Co., Inc., of Brooklyn, N. Y. Jim needs no introduction to the radio industry. Mr. Youngblood's radio career dates back to the Radio Communications service of the U. S. Navy in the first World War. He will work out of temporary quarters at 1002 W. 5th St., Marion, Ind., but shortly will move to Indianapolis.

RCA Promotes Executive Group

In the executive personnel of RCA Mfg. Co., Inc., a number of promotions have been announced by Robert Shannon, executive vice-president.

E. W. Ritter, former general manager of radio tube manufacturing, was named vice-president in charge of all the company's manufacturing and production engineering activities.

H. L. Sommerer, former manager of manufacturing, was appointed assistant to Mr. Ritter. He will direct all manufacturing activities in national defense program activities.

E. W. Engstrom, former director of

general research, was picked as manager of all research activities for the company.

E. E. Lewis was appointed assistant vice-president as executive head of accounts and finance. H. L. Beisswenger, I. T. Kitzmiller, and E. M. Moore, were named assistant controllers in respective charge of budgets, taxes and insurance; works accounting and costs; and general accounting.

AAA Expands

Chicago news for auto radio men is that the Automobile Accessories Association has moved to new and much larger quarters at 1455 S. Michigan Ave., Chicago. Garland Ames is executive secretary.

MAN AT WORK!



Homer G. Snoopshaw, (Battery Replacement Specialist), has a new position as Replacement Adviser in Bud's Radio Shop. The customer's "Down Draft Special" almost has him stumped, but Homer will figure out what batteries should be installed if it's the last thing he does—and it may be just that. After two days of this he is seeing little green megacycles with purple ohms. It's a pity Homer's boss doesn't have a copy of the Burgess Replacement Guide.*

***IT'S FREE**
See Your Burgess Distributor or write Burgess Battery Company Freeport, Illinois

BURGESS
The Complete Replacement Line

Sensational new portable automatic phonograph REMOTE-O-MATIC

Listen to it in the next room or outdoors—it's wonderful

Here is a compact portable phonograph—entirely automatic—changes 12 records. But that is not all: The REMOTE-O-MATIC can be operated by remote control. The small front section of the phonograph, containing the speaker and amplifier, can be detached and operated in the next room—complete control at your fingertips.

Because of the four-tube amplifier and high-fidelity speaker the rich full tone is comparable to a large instrument.

With the growing interest in phonograph records the REMOTE-O-MATIC will be eagerly welcomed by your customers. And—right now—it's a magnificent gift.

Send for Catalog "R-1"

Describing complete line of Portable Radios, Phonographs and Combinations

THE PORT-O-MATIC CORP., 50 East 77th Street, New York



**I'M 100%
RCP**

Pennsylvania serviceman echoes words which become more significant daily for profit-seeking test equipment dealers.

Wayne Hite of Harrisburg, Pa., speaks for hundreds of servicemen from Portland (Me.) to Pasadena when he says, "I am 100% RCP as your filing cards will show." The flawless performance of RCP Test Equipment, its long-life reliability and rock-bottom cost has won this enthusiastic support among alert servicemen. Dealers awake to the trend and genuinely interested in volume sales, extra dividends and valuable good-will, will stock and feature this fast-selling RCP dependable test equipment line. It's good business sense; and besides, there is plainly more profit in it.

**AC-DC
UNIVERSALE
DE LUXE
RCP
MULTITESTER
Model 414**



DIRECT READING capacity measurements in 5 individual ranges reading from .0001 to 300 microfarads. 4 1/2 inch Meter FUSED. 2000 ohms per volt sensitivity; accurate within 2%. Ultra sensitive low ohm range with 2 ohms center scale. • DC volts 0-5-50-250-500-5000 • AC volts 0-10-100-500-1000-5000 • DC mils 0-10-50-250-5000 • DC amps 0-1-5-25 • Capacity Mfd. 0-.03-.3-3-30-300 • Megohms 0-1.5-15 • Ohms 0-100-15,000-150,000. Open face bench type, hard wood case. Dealer Net Price. **\$21.95**

**Model 309SC
TUBE TESTER**

Tests all new miniature tubes

Tests all tubes—new miniature, regular receiving, ballast, and tubes with filament voltages up to full line. Indicates noisy tubes that would otherwise test GOOD. Hot interelement short and leakage test between all individual elements. Spare socket provision for future tubes with new base arrangements. Individual tests of each section of full wave rectifiers, duo diodes and all multi-purpose tubes. High sensitivity neon indication. Accurate calibration. Continuously variable adjustment for all line voltages from 105 to 135 volts by means of a 25 watt power rheostat. Simple and speedy to operate. Celluloid covered tube charts, deluxe line cord and plug—Double fused supply line. Dealer Net Price **\$16.95**



RIGHT NOW WRITE for Catalog No. 124. Discover the profit-possibilities in RCP's complete line of dependable Test Equipment for every need and every purse.

**RADIO CITY PRODUCTS CO., INC.
88 PARK PLACE • NEW YORK, N. Y.**

**RCP
dependable
TEST
instruments**

**Philco Auto Radio
Line in Debut**

Philco is now introducing a line of seven new auto radio sets, ranging from the popular-priced AR-10 to the many-featured AR-75, which is presented as "a de luxe set . . . the last word in tone, performance, convenience and quality."

C. E. Carpenter, the Philco Corp.'s manager of auto radio sales, declares that "all indications point to one of the greatest unit volume sales years since the inception of the first practical auto radio in 1931. Mr. Carpenter cited the record business being done by the makers of the 1941 car models, as one of the reasons for the expected peak in car receiver sales. Philco's new auto radio line is represented on "new products" pages of this issue.

**Record Bars Go to
Dealers in 9 States**

As an indication of recent interest in record merchandising, it has been reported by A. Bitter of A. Bitter Construction Corp., 2701 Bridge Plaza North, Long Island City, N. Y., that outfits in nine states have been shipped "Record Bars" during the last two months.

It was understood that much of the activity was due to preparations now being made for Christmas buying, as many dealers are expecting to demonstrate and sell thousands of records and albums as holiday gifts. As the "Bar" has extra turntables for playing records during rush shopping periods, it is seen as a fixture of special holiday importance.

The Bitter firm also makes racks, for storing and displaying records, although the "Bar" has stock space of its own. Since the change in retail prices of discs, many retailers have enlarged their stock, and extra storage facilities are needed.

**Extra Demand for
Combinations**

A sharp upturn in the demand for automatic radio-phonographs, particularly those with mahogany cabinets, is seen in a new analysis of Stromberg-Carlson sales, made by SC radio sales manager Fred N. Anibal. He pointed out that his company's new lines were specially adapted to this trend, as 10 of the units are included in the new models offered by the firm. Mr. Anibal also mentioned two additional SC sales assets; the Sapphire needle and the one-ounce pick-up.

**Brisbin to Head RCA
Equipment Promotion**

Announcement from RCA is that M. M. Brisbin, a well known expert with 12 years experience in RCA test equipment installation and service, has been transferred to Camden, N. J., to handle sales promotion and advertising on test equipment. The news comes from RCA advertising manager, D. J. Finn.

Mr. Brisbin will edit the RCA journal for servicemen, RCA Radio Service News, and will work under the direction of John P. Allen.



**Reach for a
DANDEE!**

IF ever there was a condenser that could qualify as a so-called universal or general-utility replacement, it's the new PRS 450-8 AEROVOX DANDEE. It's the most compact nidget metal-can dry electrolytic on the market . . . a genuine hermetically-sealed job . . . full-rated capacity and voltage . . . colored polarity-indicating ends . . . spun-over jacket preventing shorts and grounds—in a word, a real good electrolytic.

And now, for your convenience, these PRS 450-8 DANDEES come packed five to the box. Buy a box. Pack it in your old kit bag. And when it comes to those quick servicing jobs, just reach for a DANDEE!

Ask your Jobber . . .

Get a carton of DANDEES. Always have a box on hand. Also ask for our latest catalog. Or write us direct.



IN CANADA: AEROVOX CANADA, Limited, Hamilton, Ont.

RECORDS AND RECORDERS

Recordio Offers Many Sales-Catcher Displays



A complete set of displays, which feature color, motion, and the "girl" appeal, are being issued by Wilcox-Gay Corp., Charlotte, Mich., to show off many features of the new Recordios.

The Recordio girl display is a "Petty" type of illustration, four colors. There are two sizes of floor display cards, and a special 3-piece record display. The large console display features lighting via transparent letters, and there's a motion display for window or counter with 3-color illumination.

Also, Wilcox-Gay has Rubinoff posters, counter disc merchandisers, window posters and color cards of magazine ads. Complete displays for windows, or for "recording studio" displays, can be made up from these versatile materials.

New Dealer at Vallejo

A complete line of radios and appliances will be included in the modern home furnishings stock to be featured at the new store of John Breuner Co.,

to be opened at Vallejo, Calif., at the Virginia St. site where the Bedford Furniture Co. was formerly located. Opening is set for about Nov. 15th; Ernest Staats will be manager.

Rock-Ola Distrib Shows Recorders to Dealers

A two-day showing of Rock-Ola recorders, for dealers of northern New Jersey, was staged late last month at the Newark, N. J., Athletic Club, by Television Maintenance Co., metropolitan distributors for Rock-Ola, 220 W. 42nd St., New York City. On display and demonstration was the full string of consoles, a portable and a table model, available in various cabinet styles and woods, and priced from \$59.95 to \$169.95. Complete sets of Rock-Ola recording blanks were also shown.

A large number of dealer sales helps were announced, including offers of a free recording, direct mail pieces, store displays, etc. Executive hosts included A. V. Gartner E. Thornton Rice, Jr., and L. W. Gartner, Jr., of Television Maintenance Co.; and R. F. Laycock from the Rock-Ola factory at 800 N. Kedzie Ave., Chicago.

Vocal Xmas Cards



Customers are again interested in home-recorded Christmas greetings. You can sell 'em this Presto kit of 9 blanks, cutting needle, playing needle, all for \$5.

Victor Helps Dealers on Record Sales

A new monthly newspaper published for dealers to give away to record customers, has been announced by RCA Victor. Called "His Master's Voice," it will carry space for the retailer's imprint, and will include all new Victor and Bluebird releases.

As a further stimulant to record sales, RCA has announced a contest for disc salesmen, in which \$1100 will be awarded. A trip to Havana is the first prize; others include wrist watches and \$5 awards. Competition runs from Nov. 8 to Dec. 25.

FOR GREATER flexibility...

BRUNO connectors

by Selectar

THERE'S been no greater aid developed for Public Address service men than this balanced line of Connectors for single conductor cable and co-axial operation. Connections hitherto impossible are now made with a material saving of time and expense. Please send for complete literature, and see in how many ways this line can help your business.

"CONNECTAR" is a handy universal KIT assembled for further servicing convenience. It includes everything for making quick connections that immensely widen the usefulness of Public Address installations.

Write for details.

SELECTAR

MANUFACTURING CORPORATION

30 WEST 15TH STREET NEW YORK, N. Y.

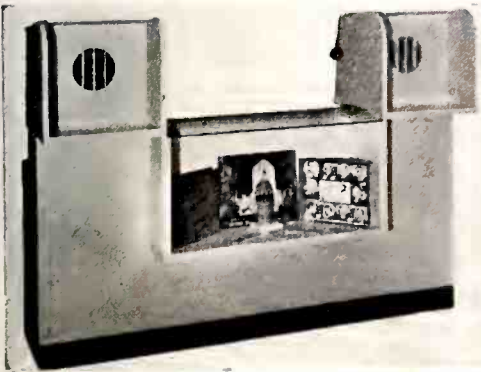

RECORD BAR*

The modern record dept. demonstrates records to four customers at one time. Has display, accessory and stock space. Price upon request.

*Reg. and copyrighted U.S. Patent office 1940.



For Profitable FALL SALES BITTER RECORD EQUIPMENT

Send for Free Folder Established 1920

A. BITTER CONSTRUCTION CORP.
27-01 Bridge Plaza North Long Island City, N. Y.

← RECORD RACK NO. 100 may be used separately or as a unit of a large record dept. Capacity 500 10" records, 500 12" records, and 75 albums.

Price \$44.00 F.O.B. Factory

MERCHANDISER NO. 27 → Suitable for display and storage purposes. Capacity 120 10" or 12" records.

Price \$2.25 Boxed F.O.B. Factory

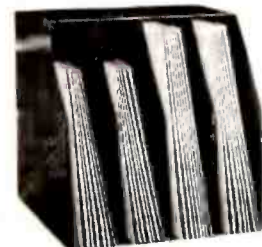



Type D UNIVERSAL Controls



STOP WASTING TIME ON VOLUME CONTROL REPLACEMENTS

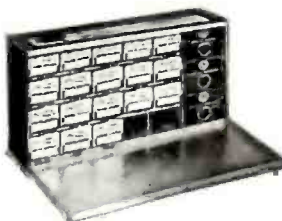

FREE!

The 18 Type D Controls, 6 switches and 5 extra Tap-in Shafts, factory-packed in this IRC Master Radiotrician's Cabinet, handle from 60% to 75% of all control replacements. You pay only \$14.97 net—the standard price of the controls, switches and shafts. The Cabinet (of dust-proof, all-metal construction) is included at no extra cost. Ask your IRC jobber to show it to you or write for folder. It's a time-saving, money-saving development no serviceman will want to miss!

Stop wasting time by ordering a volume control every time you need one for a job! Stop wasting time puzzling how to fit a control with shaft attached into a crowded chassis without removing other parts! Stop wasting time waiting for a more costly "special" replacement, when a standard IRC Type D Universal Volume Control with a special Tap-in Shaft will turn the trick!

In short, use IRC Type D Controls with Tap-in Shafts *universally*. Learn how a stock of only 18 of these controls equips you for prompt service on *about two-thirds of all types of replacements*. Study the construction of these sturdy little controls and see how amazingly superior Type D's are to ordinary midgets—fully equal in quality to the larger Type C Controls and with all the same features *plus* the added convenience of Tap-in Shafts which make them far more universal in use and much easier to install in a crowded receiver. Catalog free.



Tap-in Shafts Stay Put!
Don't pull loose.
Don't vibrate loose.

INTERNATIONAL RESISTANCE CO. 401 N. BROAD ST., PHILADELPHIA, PA.

SALES HELPS

Singer and Mike in Counter Display

A hand colored, original photograph of Dorothy Claire, the beauty who sings with Bobby Byrne's orchestra, is the new counter display now available to Electro-Voice jobbers and dealers. It is a 11 x 14 in. card, mounted and easled, and shows the new Cardak microphone, a poly-directional dynamic unit. The display comes from Electro-Voice Mfg. Co., 1239 S. Bend Ave., South Bend, Ind.

Sentinel Champ in New Display



A customer-catching new display for Sentinel's latest radio, the "Lightweight Champion" portable, has been prepared by Sentinel Radio Corp., Evanston, Ill., for use by dealers. The display, printed in Autumn colors, brown, orange and yellow, is die cut to fit snugly around the new radio. The size is 14 inches high by 11 inches wide.

RCP Offers Colorful Card

Radio City Products, Inc., now offers to dealers a new 4-color display card for wall, window or counter. This card emphasizes "low prices plus high quality and outstanding performance of the RCP test equipment." Featured is the 33-instruments-in-one, Model 411 Supertester. Dealers get these cards from RCP jobbers or direct from the company at 88 Park Place, New York City.

Instrument Offer from NU

Details on how dealers "can secure Triplet instruments for a very small deposit via special arrangements until the end of November" are now forthcoming from National Union jobbers. The announcement comes from NU headquarters at 57 State St., Newark, N. J.



KEN-RAD



DEPENDABLE RADIO TUBES

Ken-Rad Radio Tubes are dependable in service and dependable profit-makers for dealers. We invite inquiries from tube dealers and servicemen.
KEN-RAD TUBE & LAMP CORPORATION, OWENSBORO, KENTUCKY
Export Dept., 116 Broad Street, New York, U.S.A. Cable Address: Minthorne, New York

Silent Salesman Has Extra Talents

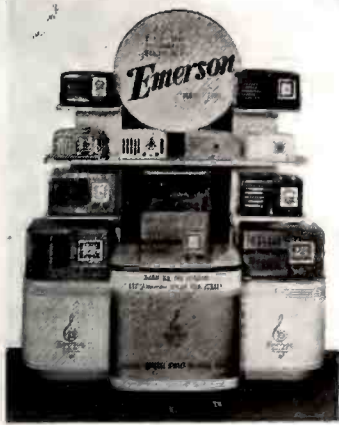

A new "Silent Salesman" display fixture, which invites customers to turn on a record and listen to a new phonoradio, is now being offered by Emerson distributors as a central unit "of an unusual merchandising plan."

The display is a rugged affair in striking colors, and has room for from 9 to 12 new 1941 sets. The unit makes it easy to demonstrate all these radios, and is easily assembled in the dealer's store.

An "Uncle Sam Hat" window and store display, which has a stirring design of red-white-and-blue colors, is forthcoming from Emerson Radio & Phonograph Corp., 111 Eighth Ave., New York City, in connection with its aggressive merchandising of the new "Patriot" model.

Stromberg Ready with Mid-Season Models

Three new automatic radio-phonographs and a table model have just been shown by Stromberg-Carlson, as mid-season units designed for the peak sales season. The combinations have the "Feather-Light Permanent Point" for playing records, and are described by SC assistant general manager Lee McCanne as "just what the dealer ordered."

The 520-PS combo is a Salem Chest design for \$175 (Eastern lists); the 520-PN is tagged at \$160, and the 520-PG is priced at \$165. The standard-plus-shortwave table job, 520J, is \$72.50 and is suggested by Mr. McCanne as "an excellent 'send-off' gift for Army and Navy officers." The new line is represented among new receivers shown on preceding pages of this issue.

Accessory Sales Expand at Philco

Philco Corp. now has a new sales department, according to news from T. A. Kennally, general sales manager for the firm. It is called the Accessory Division, and will be headed in Philadelphia by C. E. Carpenter as manager, and J. M. Skinner, Jr., as assistant manager.

The new division was started "because the increasing sales volume in tubes, auto radio and dry batteries makes these items a very large part of Philco's total business."

Model 636
\$29.95

Do you believe in Miracles?

Perhaps you don't believe in miracles, but the new Jackson 636 Tube Tester will just about convince you that there are such things. This tube tester is absolutely new, ultra-modern (a 1941 model) and complete in every detail, including ROLL CHART.

There is nothing else like the 636. No other manufacturer can possibly duplicate the Jackson DYNAMIC method of test. This method is patented and "Dynamic" is a registered Jackson trade-mark.

The Jackson Dynamic circuit is less complicated to operate yet makes a more accurate test on every tube. Model 636B, \$29.95. Portable style slightly extra. (Prices higher west of Rockies.)

THE JACKSON ELECTRICAL INSTRUMENT COMPANY
135 Wayne Ave., Dayton, Ohio



FREE!

"Learn the Truth About Dynamic Tube Testers" is a vitally important folder just off the press. Write for it today. It's free.

OHMITE Ohm's Law Calculator

Solves any Ohm's Law problem with one setting of the slide

There's nothing else like it! It's the handiest Ohm's Law Calculator ever made—specially designed for you by Ohmite Engineers. Gives the answer to any Ohm's Law problem with one setting of the slide. Simple, easy, complete. Requires no slide rule knowledge. All values are direct reading. Covers the range of cur-

rents, resistances, wattages and voltages commonly used in radio and commercial work. Also has convenient Stock Unit Selector—a setting of the slide tells the stock number of the resistor or rheostat you may need. Size 4 1/8" x 9". Available for only 10c to cover handling cost. At your Jobber, or send 10c in coin now.

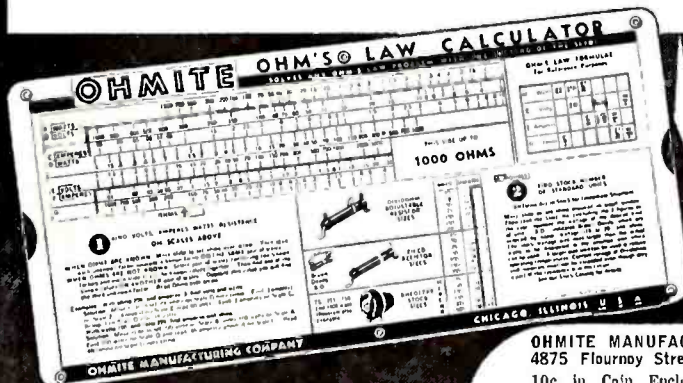

It's
NEW

It's
Complete

OHMITE MANUFACTURING CO.
4875 Flournoy Street, Chicago, Illinois
10c in Coin Enclosed. Send Ohm's Law Calculator.

Name
Address
City

Radio Today—Nov.

Be Right with OHMITE
RESISTORS • RESISTORS • TAP SWITCHES

TRIPLET

Ultra Sensitive TESTER



MODEL 1600-E
DEALER NET PRICE \$21.00

DC scales of the instrument read: Voltage 0-10-50-250-1000 (25,000 ohms per volt); 0-1-10-50-250-500 milliamperes; Resistance, low ohms, backup circuit, 1/2 to 500 high ohms, 20,000-200,000 ohms and 2 and 20 megohms. Batteries included for all ranges but 20 megohms. 22 1/2 volt battery for that range can be mounted inside the tester case; brackets provided. AC Voltage 0-10-50-250-1000 at 1000 ohms per volt. A plug-in copper-oxide rectifier, easily replaced in case of overload, is used to obtain AC readings. Model 1600-E, less case for mounting in panel. . . . Dealer Net Price . . . \$21.00. In case with handle for portable use . . . Dealer Net Price . . . \$25.50

MODEL 1270
DEALER NET PRICE \$29.83



11 ranges Test ALL Household Appliances. . . . Five Wattmeter Scale Ranges 0-20-500-1000-2000-4000 (most essential for the modern electric ranges). Four Alternating Current Scale Range 0-260 Milliamperes; 0-6.5-13-26 Amperes. Two AC Voltage Scale Ranges 0-130-260. Has REO • OOT Lifetime Guaranteed Instrument. An advanced electrical circuit analyzer that shows the wattage consumption, amperes and line voltage of ALL household appliances and small motors under actual operating conditions. Complete with leads for two-wire circuits. . . . Dealer Net Price . . . \$29.83. (Special leads available for three-wire circuits.)

"For full cooperation with the National Defense Program, Triplet engineering and production facilities are being rapidly expanded to continue the service and delivery to which our trade is accustomed."

WRITE FOR CATALOG—SECTION 1711, HARMON OR.

THE TRIPLET ELECTRICAL INSTRUMENT CO.
Bluffton, Ohio

"The Repers" Star FM in Annual Tour



Robert Thompson of Meissner Mfg. Co., who demonstrated FM during the tour of "The Repers."

Explanations and demonstrations of FM were the feature of the annual trade tour this year, conducted by "The Repers" of St. Paul and Minneapolis, a group of manufacturers' representatives who travel out of the Twin Cities each year with shop talks, displays and clinics on new radio equipment.

This year the tour included the cities of Duluth, Fargo, N. D., and Sioux Falls, N. D., besides a showing in Minneapolis. Attendance at all the meetings greatly increased over last year, and "The Repers" again receive "the plaudits of the jobbers of the Northwest for their efforts to improve the radio parts business in this area."

The featured engineering talks at each meeting were those of Marion Arvin of Mallory, and Robert Thompson of Meissner. Mr. Thompson arranged with broadcasters in each city visited, for FM demonstrations. Joe Marty of RSA conducted each meeting, and Dwight Lindborg was tour manager.

RCA Announces New Prices on Tubes

Prices of RCA radio receiving tubes have been generally revised to bring them into line with current manufacturing costs, according to L. W. Teegarden, Manager of the Tube and Equipment Division of the RCA Mfg. Co. Net prices of some types are up; others are down. New price brackets have also been set up.

The new prices concentrate approximately 40 per cent of the renewal tube business in the 90-cent and \$1 list price brackets. Slightly less than 28 per cent of the renewal business is now in the 60-cent to 80-cent bracket, while the balance of 32 per cent is in the \$1.20 to \$2.75 class.

The price revision took effect Nov. 1, and new price schedules are in the hands of jobbers handling the Cunningham, Radiotron and Victor brands.

MADE BETTER TO
WORK BETTER



• The combination of high tensile strength that assures a lasting bond, and faster, cleaner work made possible by quick-acting flux of pure water white-rosin, has given Gardiner Rosin-Core Solders an outstanding reputation for efficiency and economy on radio work by expert or amateur. Yet, due to modern production methods and big sales, Gardiner Solders cost less than even ordinary kinds. Made in various alloys and core sizes . . . and in gauges as small as 1/32 of an inch . . . in 1, 5 and 20-lb spools.



4815 S. Campbell Avenue, Chicago, Ill.



WAXES AND COMPOUNDS FOR INSULATION & WATERPROOFING of ELECTRICAL and RADIO COMPONENTS

• such as transformers, coils, power packs, pot heads, sockets, wiring devices, wet and dry batteries, etc. Also WAX SATURATORS for braided wire and TAPERS and WAXES for radio parts. The facilities of our laboratories are at your disposal to help solve your problems.

FOUNDED 1846
Zophar MILLS, Inc.
128 - 26th ST., BROOKLYN, N. Y.

INDEX TO ADVERTISERS

	Page
AEROVOX CORP.	66
ALLIANCE MFG. CO.	Cover 4
AMPERITE CO.	72
ASTATIC MICROPHONE LAB., INC.	53
BITTER CONSTRUCTION CORP., A.	67
BURGESS BATTERY CO.	65
CENTRALAB	5
CLAROSTAT MFG. CO., INC.	71
DECCA RECORDS	45
DeWALD RADIO MFG. CORP.	49
FARNSWORTH TELEV. & RADIO CORP.	3
GARDINER METAL CO.	70
GENERAL ELECTRIC CO.	7
GENERAL INDUSTRIES CO.	49
HYGRADE SYLVANIA CORP.	39
INTERNATIONAL RESISTANCE CO.	68
JACKSON ELEC. INSTRUMENT CO.	69
KEN-RAD TUBE AND LAMP CORP.	68
MAGNAVOX CO., INC.	61
MAJESTIC RADIO & TELEV. CORP.	59
MALLORY & CO., INC., P. R.	Cover 2
MEISSNER MFG. CO.	52
MEISSNER INVENTIONS, INC.	6
MUELLER ELECTRIC CO.	71
NATIONAL BROADCASTING COMPANY	28
NATIONAL CO., INC.	62
NATIONAL UNION RADIO CORP.	4
OHMITE MFG. CO.	69
PERMO PRODUCTS CORP.	48
PHILCO RADIO & TELEV. CORP.	40, 41
PORT-O-MATIC CORP.	65
POSTAL TELEGRAPH	64
PRECISION APPARATUS CO.	62
PRESTO RECORDING CORP.	63
RADIO CITY PRODUCTS CO., INC.	66
RADIO CORP. OF AMERICA	25, 26, 27
RAYTHEON PRODUCTION CORP.	37
RCA MFG. CO., INC.	29, 30, 31, 32, 72
RECOTON CORP.	45
REGAL AMPLIFIER MFG. CORP.	72
RIDER, JOHN F.	64
ROCK-OLA MFG. CORP.	49
SELECTAR MFG. CORP.	67
SENTINEL RADIO CORP.	60
SIMPSON ELECTRIC CO.	58
SUNDT ENGINEERING CO.	60
TRANSFORMER CORP. OF AMERICA	58
TRIPLETT ELEC. INSTRUMENT CO.	70
UTAH RADIO PRODUCTS CO.	2
WARD PRODUCTS CO.	35
WEBSTER-CHICAGO	56
WESTINGHOUSE RADIO STATIONS	8
WESTON ELEC. INSTRUMENT CORP.	57
WILCOX-GAY CORP.	42, 43
W. W. J. (The Detroit News)	Cover 3
YANKEE NETWORK	1
ZOPHAR MILLS, INC.	70

While every precaution is taken to insure accuracy, we cannot guarantee against the possibility of an occasional change or omission in the preparation of this index.

Sentinel Head Reports Top Sales Season

"One of the best selling seasons in the industry's history," is the way these Autumn months are described by E. Alschuler, president of Sentinel Radio Corp., Evanston, Ill. The pioneer radio executive cited "tremendous interest in the current news and the many radio improvements now available to the public at moderate prices" as reasons for the trend. Mr. Alschuler, who is chairman of the membership committee of RMA, added that "the Sentinel radio factory has never been busier than during the last two months."

Extra strength was added to this statement when the Sentinel general sales manager, George Russell, returned to Evanston following a tour of distributors and dealers in St. Louis, Little Rock, and Memphis. He reported that the dealers expected "a record-breaking year."

Federal Changes Name

The Federal Sales Co., 24-26 S. Jefferson St., Chicago, has changed its name to Federal Screw Products Co. Officials announce that personnel and policies of the firm will remain the same, and that a new catalog of Federal products will be ready soon. The company invites inquiries from parts jobbers and manufacturers interested in radio hardware.

STATEMENT OF THE OWNERSHIP, MANAGEMENT, CIRCULATION, ETC., REQUIRED BY THE ACTS OF CONGRESS OF AUGUST 24, 1912, AND MARCH 3, 1933

OF RADIO & TELEVISION TODAY, Published monthly at New York, N. Y., for Oct. 1, 1940. State of New York, N. Y., County of Westchester, N. Y. Before me, a Notary Public in and for the State and county aforesaid, personally appeared Orestes H. Caldwell, who, having been duly sworn according to law, deposes and says that he is the Editor of RADIO & TELEVISION TODAY and that the following is, to the best of his knowledge and belief, a true statement of the ownership, management (and if a daily paper, the circulation), etc., of the aforesaid publication for the date shown in the above caption, required by the Act of August 24, 1912, as amended by the Act of March 3, 1933, entitled in section 537, Postal Laws and Regulations, printed on the reverse of this form, to wit:

1. That the names and addresses of the publisher, editor, managing editor, and business managers are: Publisher, M. Clements, 277 Park Ave., New York, N. Y.; Editor, Orestes H. Caldwell, Catrock Road and Bible St., Coe Cob, Conn.; Managing Editor, Darrell Bartee, 300 Hayward Ave., Mr. Vernon, N. Y.; Business Manager, M. H. Newton, 583 W. 215th St., New York, N. Y.

2. That the owner is (if owned by a corporation, its name and address must be stated and also immediately thereunder the names and addresses of stockholders owning or holding one per cent or more of total amount of stock. If not owned by a corporation, the names and addresses of the individual owners must be given. If owned by a firm, company, or other unincorporated concern, its name and address, as well as those of each individual member, must be given.) Caldwell-Clements, Inc., 480 Lexington Avenue, New York, N. Y.; Orestes H. Caldwell, Catrock Road and Bible St., Coe Cob, Conn.; M. Clements, 277 Park Ave., New York, N. Y.

3. That the known bondholders, mortgagees, and other security holders owning or holding 1 per cent or more of total amount of bonds, mortgages, or other securities are: (If there are none, so state.) None.

4. That the two paragraphs next above, giving the names of the owners, stockholders and security holders, if in control not only of the stockholders and security holders as they appear upon the books of the company but also, in cases where the stockholder or security holder appears upon the books of the company as trustee or in any other fiduciary relation, the name of the person or corporation for whom such trustee is acting, is given; also that the said two paragraphs contain statements embracing affiant's full knowledge and belief as to the circumstances and conditions under which stockholders and security holders who do not appear upon the books of the company as trustees, hold stock and securities in a capacity other than that of a bona fide owner; and this affiant has no reason to believe that any other person, association, or corporation has any interest direct or indirect in the said stock, bonds, or other securities than as so stated by him.

(Signed) Orestes H. Caldwell

Sworn to and subscribed before me this 30th day of September, 1940.

B. M. Phillips
Notary Public Westchester County,
Notary Public N. Y. County Clerk's No. 522.
Notary Public N. Y. County Registers No. 2P227.
(My commission expires March 30, 1942).
New York County Commission expires March 30, 1942.

UNIVERSAL IN RADIO WORK

Universal Test Clip
NO. 27



For Use as a Quick and Ready Means of Connecting:

- "B" Dry Batteries
- Oscillation Transformers
- Helices
- Tubes
- Anywhere for electrical contacts
- Also for holding crystals

(The above ad appeared in May, 1922. While clips for "B" batteries and "holding crystals" are no longer in style—still more clips than ever are used today for 1001 modern applications.)

Send for Free Samples & Catalog 980

Mueller Electric Co.

1573 E. 31ST. ST. CLEVELAND, OHIO

A Better POWER RHEOSTAT



Resistance winding on insulated aluminum core.

Heat-resistant ceramic body. Cold-setting cement. Ceramic rotor insulator. Unique tripod-type rotor. Graphited-copper contact rides third rail and winding.

25-watt rating even at one-third setting. A brute for punishment.

★ For years Clarostat engineers have worked for a better power rheostat. They have examined, tested, compared, all types. Hundreds of models have been built. And now comes the end result—the new Clarostat Power Rheostat. It's different. One trial will convince you that new standards have been set for power rheostats.

Ask for MANUAL . . .

★ If you do service work, ask our jobber for a Clarostat Service Manual. Ask for data on the new power rheostat. Or write direct to Clarostat Mfg. Co., Inc., 281 N. 6th St., Brooklyn, N. Y.



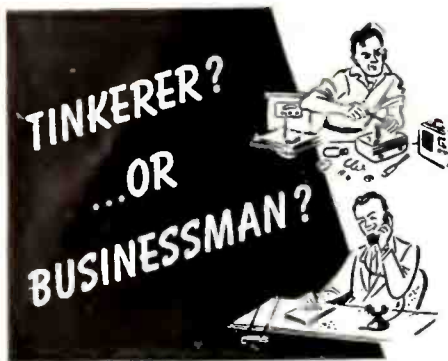

LESS Time to Repair Radios ...
Means MORE Time to Build Business!

RCA RIDER CHANALYST



Yesterday's servicing methods were good enough . . . for yesterday. But progressive servicemen *today* demand methods that fix sets quicker. They spend less time bending over receivers—more time going out after business . . . developing business-getting ideas . . . building their business.

Signal-tracing with the Rider Chanalyst takes less time!

Greatest advance in radio servicing instruments since servicing began, the RCA Rider Chanalyst uses the newest method of attack: *the signal itself*, common to every radio. It's an investment worth investigating! Ask your RCA Distributor for on-the-circuit proof of the Chanalyst's effectiveness by means of the Dynamic Demonstrator.

"Line 'em up" Faster, Easier, Better!
NEW RCA A. C. TEST OSCILLATOR
No. 167 . . . \$34.50 to servicemen

- ★ New, Accurate, Easy-Reading Dial
- ★ 100-30,000 KC. Fundamentals: 6 Bands
- ★ Full 1.0 Volt Maximum Output
- ★ 30%, 400-Cycle Internal Modulation

Over 380 million RCA Radio Tubes have been purchased by radio users. In tubes, as in parts and test equipment, it pays to go RCA All the Way.



RCA
Test Equipment
RCA Manufacturing Co., Inc., Camden, N. J.
A Service of the Radio Corporation of America

"The Representatives" Expand Organization Activity

New members, and new regional chapters are being announced by "The Representatives," the industry's organization of manufacturers' representatives, following Fall meetings of the group. National officers of the organization, named at the sixth annual election, are S. K. MacDonald, Philadelphia, president; Matthew Camber, New York City, vice-president; and David Sonkin, 220 E. 23rd St., New York City, secretary-treasurer.

The ten new representatives elected to membership are Gary Granat, 323 So. Franklin St., Chicago; Dave M. Lee, 1001 Westlake Ave. N., Seattle, Wash.; R. O. Lund, 1720 N. Damen Ave., Chicago, Ill.; Wallace B. Swank, 6432 Cass Ave., Detroit, Mich.; G. A. Stoll, 139 Alton Ave., Dayton, Ohio; G. G. Willison, 306 West Bldg., Houston, Texas; L. H. Jackman, 7600 Euclid Ave., Cleveland, Ohio; E. B. Lundgren, 606 Mfrs. Exch. Bldg., Kansas City, Mo.; Ernest Peck Scott, 1836 Euclid Ave., Cleveland, Ohio; John Keffe, Jr., 265 Drexel Bldg., Philadelphia.

NEW ENGLAND CHAPTER

One of the new regional chapters is the New England group, headed by Ernest Seyd, president, and Harry Gerber, sec'y-treas. Members include Tim Gerber, Waldo F. Kelleigh, Raymond F. Perron, Harrison Reynolds, Henry P. Segal, Ernest Seyd, and P. R. Sturgeon.

The other new chapter is the Southwestern one, with George E. Anderson, president, and J. E. Earl, vice-pres. Members, besides Mr. Anderson and Mr. Earl, include George H. Pierce, Edward F. Aymond, A. L. Berthold, R. M. Campion, Hal F. Corry, J. P. Kay, M. B. Patterson, B. G. Paylor, J. Y. Schoonmaker, Earl Smith, and G. G. Willison.

The application of a third chapter, the "Dixie" is now pending.

"The Representatives" report that a number of members have moved; here are the new addresses: R. W. Farris, 127 E. 31st St., Kansas City, Mo.; John O. Olsen, 1456 Waterbury

Rd., Lakewood, Cleveland, Ohio; I. Golden, 152 W. 42nd St., New York, N. Y.; Ben Joseph, 258 Broadway, New York, N. Y.; J. A. Simberkoff, 347 Fifth Ave., Syracuse, N. Y.

President Macdonald has named a number of committees: the Board of Governors includes D. R. Bittan, Perry Sattler, David F. Tobias, Ben Joseph and John Kopple. Appointed for the membership committee are Mr. Bittan, Adolph Friedman, Leo Freed, John M. Forshay, and Howard P. Smith. On the entertainment committee are C. B. Cooper, Bob Smith, and Jules Sussman. The new publicity director is Ben Joseph.

- 4 STANDARD TYPES of Amperite Regulators replace over 200 types of AC-DC Ballast Tubes now in use.
- Not to be confused with ordinary dropping resistors. Amperite actually regulates.
- Amperite Regulators are equipped with a patented Automatic Starting Resistor which prevents initial surge and saves pilot lights.
- Amperite AC-DC Regulators; List \$1.00. Amperite Replacements for 2V Battery Set ballasts List \$1.25

WRITE FOR REPLACEMENT CHART "S"

AMPERITE Co. 561 Broadway, N. Y. C.

AMPERITE

WE KNOW THE ANSWER!

Our years of EXPERIENCE in engineering and manufacturing high quality INTERCOMMUNICATIONS SYSTEMS make "difficult jobs" easy — for US!

If you have an intercommunications problem, consult our engineering department without obligation. Literature and price list on request. Describes systems from two to twenty stations.

REGAL AMPLIFIER MFG. CORP.

Intercommunications Headquarters
14-16 West 17th St. Dept. RT-11 New York, N. Y.

WWJ

America's Pioneer Broadcasting Station

Now in 21st Year!

TWENTY YEARS AGO a small but curious group of spectators gathered in a little room on the fourth floor of The Detroit News building. It was the evening of August 20, 1920—the evening of WWJ's first broadcast, which, incidentally, was *the first regularly scheduled program* broadcast by any radio station in America. A cardboard horn stood before a telephone "mike" on a 20-watt de Forest transmitter. Operators excitedly adjusted dials, and then "Annie Laurie" and "Roses of Picardy" were played on a phonograph. Someone then played "Taps" and the first WWJ broadcast was over.

TWENTY YEARS have brought much progress to the science of radio and broadcasting. Twenty years of broadcasting have brought great advances and prestige to WWJ also—and a background rich in experience, memories and accomplishments. For not only has WWJ fully kept pace with the rapid development of the radio industry, but of even greater importance it has gained, and held, a listener-preference in Detroit unsurpassed by any other radio station in Michigan . . . equalled by few radio stations in the world.

*Established
August 20, 1920*



*Member NBC
Basic Red Network*

National Representatives

The Geo. P. Hollingbery Company

New York: Chicago: Atlanta: San Francisco: Los Angeles

The Choice of the Leaders

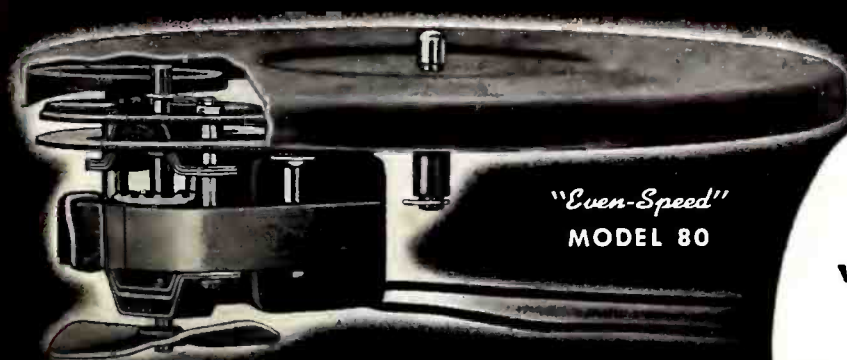

ALLIANCE *"Even-Speed"* PHONO-MOTORS

THERE'S AN "Even-Speed" MODEL FOR ALL COMMERCIAL FREQUENCIES AND VOLTAGES

SPECIFICATIONS:

MODEL 80. "Even-Speed" Model 80 is available for operation on 110 or 220 volt, 40, 50 or 60 cycle source at 16 watts input in 8", 9" or 10" turntable sizes (Model K for 110 or 220 volt, 25 cycle operation in 8" or 9" turntable sizes and is interchangeable in mounting with Model 80). Both are exceptionally quiet in operation—no gears—smooth, positive friction rim drive. Excellent regulation characteristics for uniformity of table speed. Ample proportioned bearings—large oil reserves. Forced ventilation for cool operation. Slip type fan precludes possibility of injury. Mounting plate maintains correct turntable height regardless of mounting board thickness.

MODEL 60, ALLIANCE'S FINEST PHONO-MOTOR. Available for operation on 110 or 220 volt, 50 or 60 cycle source at 14 watts input. Self-starting—maintains constant record speed. Designed for superior speed regulation under wide variations of voltage, load and temperature. Large bearings, ample oil reserves. Laminated bakelite helical cut gears for quiet operation, completely enclosed and protected. Forced ventilation for cool operation. Universal mounting plate maintaining correct turntable height with any thickness of mounting board. Available with 8", 9" or 10" turntable tops. Motor dimensions: Length 4 $\frac{3}{8}$ "; width 3 $\frac{1}{8}$ "; depth to mounting plate 3 $\frac{1}{4}$ ". Precision assembly for uniform production.

ATTENTION JOBBERS— Each motor and turntable unit is packed in a handy, individual display carton

IDEAL REPLACEMENT UNITS

The same dependability and performance that has made "Even-Speed" phono-motors the industry's first choice as original equipment is also making them the service man's first choice as replacement units.

The low cost of "Even-Speed" motors makes it more practical and more profitable to replace the entire motor and turntable unit, in case of trouble, than to attempt what may prove to be a difficult repair job. All Alliance phono-motors are easily and quickly installed, and fit practically all standard phonograph and combination models.

DEALERS AND SERVICE MEN

Ask your jobber or mail a postcard today for prices and complete information on the complete "Even-Speed" line of phono-motors.

**ALLIANCE MANUFACTURING COMPANY
ALLIANCE, OHIO**



NO MOTORS BETTER BUILT OR BETTER ENGINEERED